



General catalog

Clothing and personal
protective equipment

**20
24**

WE ARE PIP GLOBAL



INDUSTRIAL STARTER
Individual Protection Specialist since 1962 in Europe, he is now part of the family
PIP GLOBAL SAFETY



PIP Protective Industrial Products
Leading group in the production and distribution of safety gloves and PPE with over 35 years of history and presence in North America, South America, Europe, Asia and Australia.

+ 1800 employees

11 production plants

+ 20.000 references

33 offices worldwide

+186.000 m² of centers of distribution

Present in 18 states



OWN BRANDS



Clothing
Footwear
Filtering facials
Gloves
Eyeglasses



Fall arrester
Helmets



Gloves



Eyeglasses



Gloves

PIP

GLOBAL SAFETY

Where are we in Europe?

PIP EMEA

PIP |  KIT

PIP |  Ultimate Industrial

PIP |  ISM

PIP
FRANCE

PIP |  INDUSTRIAL STARTER

PIP Europe

In 2006, PIP® opened sales offices and warehouses in Italy, Greece and Spain.

These activities were initiated in collaboration with local partners, who invested in the company to promote its rapid growth through extensive operational plans throughout Europe.

Although the business has grown in Europe, economic instability and inherent challenges have led to many unforeseen structural changes. However, PIP®'s presence in Europe has resulted in strong alliances and relationships.

Most recently, in 2016, PIP® decided to consolidate all of its European operations by opening a single entity, PIP France.

The challenge for PIP France was to harmonize its product line and market entry strategy.

Within two years, PIP France doubled sales and optimized the offerings of PIP®'s main brands-G-Tek® for hand protection and Bouton® for eye protection.

Given the enormous success achieved in such a short period, in 2018 PIP France joined the PIP Global family as the hub of our activities in France and Northern Europe.

As of today, PIP Global safety's position in the European market is much stronger thanks to the acquisitions of Industrial Starter Group and Kit Safety, which allowed PIP to expand its presence with offices in Italy, Spain, Poland, the Czech Republic, and Ireland.

Important brands recognized worldwide



YOUR WORK MATTERS, WORKWEAR

Safety, comfort and style for workers start here. Our challenge is to design durable, comfortable and attractive garments so that workers feel good about what they wear to work. Products characterized by the use of technical materials in combination with Italian pattern and style. Specialists in stretch fabric.



WHEN WORKING AT HEIGHT USE MAXIMUM SAFETY

A whole range of fall arrest systems, devices and lifelines for work at height. Regardless of the risk and level, Akrobat offers you the solution for your needs, complying with the strict EU regulations for work at height.



CONFIDENCE TO DO THE JOB™ WORK GLOVES

G-Tek® is where mechanical protection meets optimum levels of dexterity, fit and form in technical gloves. With the most versatile line of supports and coatings to meet every worker's needs.



ADVANCED LENS TECHNOLOGIES IN SAFETY EYEWEAR™ VIEW PROTECTION

Bouton® designs innovative and stylish protective eyewear that workers want to wear. Our high-performance glasses offer superior comfort and feature advanced lens technology that protects and enhances vision.



ADVANCED NON-SLIP TECHNOLOGY DISPOSABLE GLOVES

Grippaz® technology features a fish scale pattern that provides unparalleled grip performance. Grippaz® gloves are ergonomically designed to provide traction grip on both the outside and inside of the glove. The proprietary Grippaz® nitrile formula offers greater flexibility and fits more snugly than traditional gloves, providing maximum comfort, durability and dexterity.



INDEX

ISSALINE CLOTHING

WINTER	5 - 29
HEADGEAR	28
VARIOUS WORKWEAR	29 - 42
STRETCH WORKWEAR	43 - 71
STRETCH EXTREME	60 - 64
T-SHIRTS - POLO SHIRTS - SHIRTS	65 - 69
TECHNICAL SOCKS - UNDERWEAR	72 - 74
HIGH VISIBILITY WINTER	75 - 78
HIGH VISIBILITY COTTON POLYESTER	79 - 80
HIGH VISIBILITY WAISTCOATS - T-SHIRTS - POLO SHIRTS	81 - 83
HIGH VISIBILITY WATERPROOF	78

SPECIAL CLOTHING

ISSALINE M-PRO MULTIPROTECTION	84 - 86
ISOTHERMALS	87
FORESTRY	88
PIP HEATING WAISTCOAT - COOLING TOWEL	89
ISSALINE SINGLE-USE COVERALL	90 - 91
APRONS	91
ISSALINE WATERPROOF	92

ISSALINE GLOVES

ICONOGRAPHY OF USE	94 - 95
NITRILE	96 - 98
POLYURETHANE	98 - 99
LATEX	100 - 101
BISPALMATIC	100
GARDENING	101
INDUSTRIAL	102
SAFETY NITRILE	104 - 105
SAFETY PVC TEXTILES	106
SAFETY SINGLE USE GLOVES	107
SAFETY LEATHER	108 - 109
SAFETY ELECTRICALLY INSULATING	110
ANTI-HEAT - STEEL	111
WELDING LEATHER - DOCKER	112 - 113
WINTER	114
WORK & SPORT	115 - 116

G-TEK GLOVES

SAFETY RECYCLATES	124 - 125
SAFETY ANTI-CUT	126 - 128
PRECISION	129
GENERAL PURPOSE	130
WINTERWEAR	130

GRIPPAZ GLOVES

SAFETY SINGLE-USE NITRILE	132
---------------------------	-----

BREATING PROTECTION

ISSALINE FILTERING AND NON-FILTERING MASKS	134 - 135
--------------------------------------------	-----------

HEAD PROTECTION

ISSALINE HELMETS	136
AKROBAT HELMETS	137 - 138

WELDING PROTECTION

VARIOS	139 - 141
--------	-----------

SIGNAGE AND VARIOUS EQUIPMENT

142 - 143

BOUTON EYE PROTECTION

SPORT	147 - 149
INDUSTRIAL	150 - 153
CLASSIC	155
GOGGLES	156 - 157
SOLAR	158
OTG - VISORS	159
ACCESSORIES - DISPLAYS	160

PIP HEARING PROTECTION

SINGLE-USE AND REUSABLE EARPLUGS	161 - 169
EARMUFFS	171

PIP HEATING WAISTCOAT - COOLING TOWEL	172
---------------------------------------	-----

FALL ARRESTOR

AKROBAT	173 - 192
---------	-----------

SHOES

ISSALINE INDUSTRY	194 - 201
ISSALINE INDUSTRY PLUS	197
ISSALINE EXTREME	202 - 203
ISSALINE PROFESSIONAL & SPORT	204
ISSALINE WHITE - CLOGS	206 - 207

ISSALINE BOOTS

PVC - NITRILE - POLYURATHANE	209 - 211
------------------------------	-----------

SALUBER

INSOLE	212
--------	-----

MERCHANDISING

ISSALINE WALL	214 - 217
ISSALINE MODULAR SYSTEM	218 - 220
ISSALINE MODULAR WOOD	221 - 222

MERCHANDISING SUPPORTS

DISPLAYS, BANNERS, MANNEQUINS	223 - 224
-------------------------------	-----------



Practical for leisure, perfect for work.

Our target, our challenge, is to realize durable, comfortable and even attractive garments; to make this we use technical fabrics, we cooperate with experienced designers and pack the product in qualified and reliable laboratories.

What is all this about ?

Workwear or sportwear for leisure?

Leave it to you to judge.

ICONS

To help you quickly identify the main features of the articles. ICONS To let you easily find the products' main features.



SOFT SHELL

These products are manufactured with a technical fabric that gives to the garment extra protection against weather conditions thanks to its feature against wind, waterproofness and breathability.



WIND PROOF



BREATHABLE

Products manufactured with breathable fabric that keeps the body dry for a better comfort.



WATER PROOF

Products manufactured with waterproof fabric.



TEFLON TREATMENT

Teflon® TREATMENT A product Teflon treated on its surface grants water repellency. The fabric of these products with treatment on their surface are more resistant to dirt.



ROLLER KEYS

Products equipped with a very nice and useful gadget inside a pocket. It is an expandable and retractable nylon yarn with a little karabiner for hooking your keys and not lose them anymore.



4 WAY STRETCH

It is an elastic fabric that has the same elasticity in all directions, thus guaranteeing the worker excellent freedom of movement.

WHAT IS THIS YELLOW LABEL?

All our garments equipped with a yellow label showing the RdP number (Test Report) / Certificate issued by the Ritex accredited laboratory, are certified as PPE in "CAT. I" while garments that are not CE marked or generically CE marked, or not accompanied by certification, ARE NOT PERSONAL PROTECTION DEVICES, but generic clothing.

The tests necessary for the RdP / certificate also serve to check the resistances of the materials that must be equal to or higher than our standards.





Workwear.

Performance, Style and Safety.

ISSALINE workwear is the ideal choice for professionals who want a functional, durable and stylish outfit to face every working day with confidence. With a focus on quality and attention to detail, our clothing line guarantees maximum performance for workers in every field.

Key Features:

high-quality materials. We use resistant and durable fabrics to ensure that our garments are ready to withstand the daily challenges of the job.

Ergonomic design:

ISSALINE clothing is designed with an ergonomic design to ensure a comfortable fit and optimum freedom of movement.

Protection for all Occasions:

From windproof and rainproof jackets to protective suits and reflective vests, we offer solutions for every working condition.

Integrated functionality:

our garments are equipped with pockets and compartments strategically positioned to facilitate the transport of essential tools and equipment on the job.

Professional Style:

combine performance and style with our modern and stylish garments designed to give a professional and well-groomed appearance to the worker.

Whether you are a bricklayer, gardener or industrial technician, ISSALINE workwear provides you with the safety and comfort you need to tackle your tasks with confidence and style. Choose ISSALINE for a reliable outfit and superior quality, and discover how our clothing can contribute to your success at work.

Note: The certification values shown in this catalogue may vary due to the continuous updating process; for exact data, please ask for updated technical data sheet.

8815B

16-368-EN

9035B

SUSTAINABILITY is not a trend for us, but a process.

As a company with global economic relations, we are committed to complying with applicable legislation, respecting social and ecological standards, and thus acting sustainably throughout our global value chain. Responsibility towards people and the environment is constantly implemented comprehensively, continuously improved and is deeply anchored in our core processes and products.



We reduce the use of plastic and we use cardboard boxes.

We are firmly committed to reducing the use of plastic or plastic-derived packaging (where possible); using recyclable cardboard boxes.

Sustainable boxes. ISSALINE is committed to using this packaging system, which is ecologically more sustainable than plastic. A packaging system that not only helps us generate less environmental impact, but also facilitates the display of the product in the shop, an added value to the product.



clothing made from **recycled*** material

*See specifications in the article composition.



GREEN HEART®

GREEN HEART FOR A BETTER WORLD

In products' field, we take our responsibility and meet demands of partners, end customers and retailers for eco-friendly articles by developing sustainable products under the Green Heart label.



04506B KIDDY



04508B KIND



04527B POSH



8883B TUBE

ISSALINE
BY PIP

SOFTSHELL WATERPROOFNESS BREATHABILITY



WP - WATERPROOFNESS: is measured in mm reached by a water column placed over the fabric before the water pass through it: the higher the column (higher pressure) the more waterproof the fabric.

BR - BREATHABILITY: is measured in mvp that's the qty of water vapour (in grams) that vaporises through one square meter fabric over a 24 hour. The larger the number, the more breathable the fabric.

SOFTSHELL Issa garments use tPu membrane from sportwear that allow to combine two features, waterproofing and breathability, considered incompatible for long time. Issa membrane presents thousands of tiny holes, small enough not to pass the water molecule, but large enough to allow vapor perspiration so as to keep the body dry and body temperature pleasant.

The body of an adult man can produce a quantity of sweat per hour equal to 50 ml in resting phase, one liter per hour during heavy work activities and up to four liter during an Olympic marathon. It can be easily understood that the sweat that cannot be transferred outside stays on the skin and soaks clothes causing a cold effect in winter and hot one in summer.

NEW
colour
grey



04508B KIND

CE CAT. I - EN ISO 13688:2013

Waterproof and breathable softshell made entirely of recycled material, equipped with three front pockets and two large full pockets; drawstring at the waist for a better fitting. This jacket match with Boom pants 9030B, 9032B and 9035B. The garment is made from recycled materials and in line with this choice, the packaging is in cardboard boxes and not in plastic.

Composition: 100% recycled 150D polyester bonded with 100% recycled fleece
g/m²: 320

TPU membrane (recycled): W/P 3.000 mm e MVP 1.000 g/m²/24 h.

Sizes: S-M-L-XL-XXL-3XL-4XL-5XL

Colour:

040 blue with black inserts,

080 grey,

081 anthracite grey with black insert.



Full box: 10 pcs.



04508D

M/2 - L/2 - XL/2 - XXL/2 = 8 box

04506B KIDDY
page 19



04527B POSH

CE CAT. I - EN ISO 13688:2013

Softshell jacket with high levels of waterproofing and breathability, equipped with high visibility inserts on the shoulders and chest (even if it does not meet the requirements of the specific EN20471 standard). The front has two lower pockets and one on the chest, the latter has a taped zip while inside two large pockets ensure high capacity. Drawstring at the waist and concealed hood are two further technical features of the product. The garment is made from recycled materials and in line with this choice, the packaging is in cardboard boxes and not in plastic.

Composition: 96% recycled polyester 4% spandex bonded with 100% recycled fleece
g/m²: 310

TPU Membrane: W/P 8.000 mm e MVP 3.000 g/m²/24 h.

Sizes: S-M-L-XL-XXL-3XL-4XL-5XL

Colour:

083 anthracite grey with black inserts



Full box: 10 pcs.



04527D

M/2 - L/2 - XL/2 - XXL/2 = 8 box



TPU MEMBRANE



LADY



04515N (04515NB) JUST

CE CAT. I - EN ISO 13688:2013

All - new softshell jacket features four pockets and highly soft fabric as well as technical. Equipped with high visibility piping inserts and practical roller key holder.

Composition outer part: 94% polyester, 6% spandex bonded microfleece
g/m² exterior: 310

TPU Membrane: W/P 8.000 mm e MVP 1.000 g/m²/24 h.

Padding: no.

Sizes: XS-S-M-L-XL-XXL-3XL+

colour 040-060-80 **4XL-5XL**

Colour:

040 blue retro-reflective inserts grey,
060 black retro-reflective inserts grey,
080 grey retro-reflective inserts grey,
070 red retro-reflective inserts grey.

box
Full box: 10 pcs.

04509 SNAPPY
page 18



04515NL JUST LADY

CE CAT. I - EN ISO 13688:2013

softshell jacket for women has four pockets and a particularly soft but technical fabric. Fitted with high-visibility piping and a handy key ring roller.

Composition outer part: 94% polyester, 6% spandex bonded microfleece
g/m² exterior: 310

TPU Membrane: W/P 8.000 mm e MVP 1.000 g/m²/24 h.

Padding: no.

WOMAN Sizes: S-M-L-XL-XXL

Colour:

040 blue retro-reflective inserts grey,
060 black retro-reflective inserts grey, only on request
070 red retro-reflective inserts grey, only on request

Single packed in a poly bag for hanging
Full box: 10 pcs.

ISSALINE
PIPWINTER
PROTECTION

PADDED

04520
PERFECT

CE CAT. I - EN ISO 13688:2013

This jacket is the ideal choice for those who do not want to give up the convenience of softshell even during the coldest winter days as the additional padding further increases the natural resistance to cold, typical of this technical fabric.

Composition outer part: 94% polyester, 6% spandex bonded microfleece
g/m² exterior: 310

TPU Membrane: W/P 8.000 mm e MVP 1.000 g/m²/24 h.

Padding composition: 100% polyester

g/m² Padding: 80 sleeves / 100 body

Sizes: XS-S-M-L-XL-XXL-3XL+
colour 040-060 **4XL-5XL**

Colour:

040 blue retro-reflective inserts grey,

060 black retro-reflective inserts grey,

080 grey retro-reflective inserts grey,

Single packed in a poly bag for hanging
Full box: 10 pcs.

PADDED



EN 14058:2017

04522
FOXY

CE CAT. I - EN ISO 13688:2013 - EN 14058:2017

Suitable for all those who love the typical features of the Softshell (waterproof, breathable, and wind-resistant) but are looking for an higher thermal coefficient. Extremely lightweight. Padded softshell with five outer pockets with taped zippers and two inner pockets. Adjustable and detachable hood and collar lined by soft micro fleece. Equipped with a practical roller key holder.

Composition outer part: 94% polyester, 6% spandex bonded microfleece
g/m² exterior: 240

TPU Membrane: TPU W/P 8.000 mm e MVP 800 g/m²/24 h.

Padding: 100% polyester.

g/m² Padding: 100.

Sizes: S-M-L-XL-XXL-3XL-4XL-5XL

Colour: 060 black with red inserts.

Single packed in a poly bag for hanging
Full box: 10 pcs.

PADDED



EN 14058:2017

04523
DEER

CE CAT. I - EN ISO 13688:2013 - EN 14058:2017

Padded softshell waterproof and breathable jacket, provided with four taped zippers outer pockets and two inner pockets, adjustable and detachable hood. Easy dress system for waist size adjusting. Collar lined by soft micro fleece.

Composition outer part: 94% polyester, 6% spandex bonded microfleece
g/m² exterior: 240

TPU Membrane: TPU W/P 8.000 mm e MVP 800 g/m²/24 h.

Padding: 100% polyester.

g/m² Padding: 100.

Sizes: S-M-L-XL-XXL-3XL

Colour: black with red inserts.

Single packed in a poly bag for hanging
Full box: 10 pcs.



ISSALINE
by PIP

WINTER JACKET



**SUPER
STRETCH**



04529B SPRINGER

CE CAT. I - EN ISO 13688:2013

Stretch jacket thanks to the innovative fabric that gives the garment an incredible elasticity and consequently is characterized by high comfort. The garment is equipped externally with two pockets plus a third document holder, inside there are two large pockets.

Composition outer part: 83% nylon, 17% spandex
g/m²: 340

Padding: no

Sizes: S-M-L-XL-XXL-3XL

Colour:

040 blue with orange inserts,
060 black with inserts yellow,
080 grey with inserts red



Full box: 10 pcs.



04529D

Sizes: S/1 - M/2 - L/3 - XL/3 - XXL/2 - 3XL/1 = 12 pcs.



04526B RUSH

CE CAT. I - EN ISO 13688:2013

Softshell with four taped zips for improved water resistance, detachable hood, three outside pockets and two large inner pockets. The garment features an original asymmetric design that makes it ideal even for non-work use.

Exterior composition grey: 65% polyester, 35% cotton

Exterior composition black: polyester piquet

g/m²: 320 g/m²

TPU Membrane: W/P 8.000 mm e MVP 800 g/m²/24 h.

Padding: no.

Sizes: S-M-L-XL-XXL-3XL

Colour: 083 grey with inserts black,



Full box: 6 pcs.



04526D

Sizes: M/1 - L/2 - XL/2 - XXL/1 = 6 pz .



8880B SILKY EXTREME

CE CAT. I - EN ISO 13688:2013

The Extreme line SILKY jacket is among the most technical garment in the Issa range; supposedly it is a soft technical jersey but in reality it is a modern waterproof and breathable softshell with antiabrasion fabric inserts. Hood and 4 large outer pockets plus 2 inside complete the product making it unique in its kind.

Composition: 100% polyester a maglia

g/m²: 400

Contrast composition: 94% polyester, 6% spandex

g/m²: 330 / 350

TPU Membrane: W/P 8.000 mm e MVP 3.000 g/m²/24 h.

Padding: no

Sizes: S-M-L-XL-XXL-3XL

Colour:

040 blue with inserts black,

080 grey with inserts black,



Full box: 6 pcs.



8880D

M/1 - L/2 - XL/2 - XXL/1 = 6 pcs.



ISSALINE
PIP

TPU MEMBRANE



DETACHABLE SLEEVES



8884B CLEVER EXTREME

CE CAT. I - EN ISO 13688:2013

Extreme line technical softshell with detachable sleeves, HI-VI inserts, highly breathable membrane, non-detachable hood and taped zips.

Composition outer part: 94% polyester, 6% spandex bonded microfleece

g/m² exterior: 330, contrasting fabric 350

TPU Membrane: W/P 8.000 mm e MVP 3.000 g/m²/24 h.

Padding: no

Sizes: S-M-L-XL-XXL-3XL

Colour:

040 blue with inserts black and retroreflective grey,

080 grey with inserts black and retroreflective grey,



Full box: 6 pcs.



8884D

M/1 - L/2 - XL/2 - XXL/1 = 6 pcs.

8882B CUNNY

page 18



DETACHABLE SLEEVES



04518N SLY

CE CAT. I - EN ISO 13688:2013

Softshell waterproof and breathable jacket with detachable hood and sleeves. By taking off the sleeves, it becomes a practical vest also for milder seasons. Provided with four 4 outer pockets and two large inner ones. Water protection cover flap for sleeves zippers' closure.

Composition outer part: 94% polyester, 6% spandex bonded microfleece.

g/m² exterior: 310

TPU Membrane: W/P 8.000 mm e MVP 800 g/m²/24 h.

Padding: no

Sizes: XS-S-M-L-XL-XXL-3XL

Colour: 083 grey with inserts black



Single packed in a poly bag for hanging

Full box: 10 pcs.



04094B BONNY

CE CAT. I - EN ISO 13688:2013

Technical jacket with fixed hood, two large front pockets and one document pocket, two large inner pockets and one "napoleon pocket". Waist drawstring to adjust fitting.

Composition outer part: 94% polyester, 6% spandex bonded microfleece

g/m² exterior: 310

TPU Membrane: W/P 8.000 mm e MVP 800 g/m²/24 h.

g/m² Padding: 140

Sizes: S-M-L-XL-XXL-3XL

Colour:

083 grey with inserts black



Full box: 6 pcs.



04094D

Sizes: M/1-L/2-XL/2-XXL/1 = 6 pcs. .



NEW



**8888B
ICONIC EXTREME**

CE CAT. I - EN ISO 13688:2013

"Iconic" Jacket from the ISSALINE EXTREME line combines style and functionality to meet daily challenges. Made with nylon main fabric and contrasting softshell, it adapts to multiple uses. Zippered side, chest and forearm pockets offer practicality and functionality. An inside pocket carries cell phone on the worn left side and an internal zippered storage pocket on the right side add further practicality. The hood increases versatility in variable conditions. High-tenacity fabric is featured on the upper back, shoulders and cuffs. Reflective piping on the upper back, although it do not meet the minimum requirements for high visibility, increase visibility in low light conditions. Aesthetically appealing and technologically advanced, it is an ideal choice for work and leisure.

Plus:

- Interior zipper to facilitate any customizations
- Elasticized cuffs
- High tenacity fabric sleeve bottoms
- Reflective piping inserts
- High-tenacity fabric inserts
- Wrap-around hood.

Composition:

Main fabric: 100% nylon

Contrast fabric: softshell 94% polyester, 6% spandex.

Filling g/m²: 200

Sizes: S-M-L-XL-XXL-3XL-4XL-5XL

Colour:

040 navy blue with black inserts,
081 anthracite with black inserts.



box

Full box: 6 pcs.



display

8888D

M/1 - L/2 - XL/2 - XXL/1 = 6 pcs.

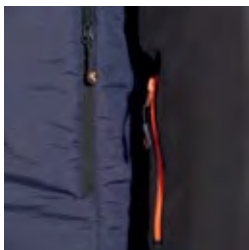

Zippered pockets on the forearm and on the bust.



Elasticized cuffs and high tenacity at the bottom of the sleeve.



Bottom adjustable drawstring.

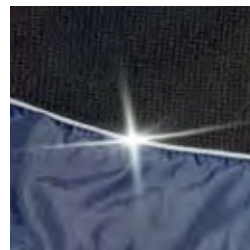

High-tenacity fabric and reflective piping on the upper back.

263-NP332-EN

250-87-0020-EN

8888B

16-541-EN

8025BP

46300



BRAVE WORKERS



RESISTANT FABRIC WITH MEMBRANE

DETACHABLE SLEEVES



EN 14058:2017



TPU MEMBRANE

04531B WISE

CE CAT. I - EN ISO 13688:2013 - EN 14058:2017

Winter jacket in high resistant fabric ideal for "demanding" environments such as construction; detachable sleeves, foldaway hood, four front pockets and a large inner pocket. Reflective fabric inserts to improving visibility while not respecting the minimums required by specific legislation for high visibility.

Composition outer part: polyester dobby

g/m² exterior: 240 g/m²

TPU Membrane: W/P 5.000 mm e MVP 1.000 g/m²/24h.

Padding: 120 g/m².

Sizes: S-M-L-XL-XXL-3XL- 4XL-5XL

Colour:

040 light-blue with blue inserts, 083 grey with black inserts.



Full box: 6 pcs.



04531D

Sizes: M/1-L/2-XL/2-XXL/1 = 6 pcs.



9060B WISE page 57



04533B LUCKY page 20

HIGH RESISTANT MEMBRANE



EN 14058:2017



TPU MEMBRANE

04532B KEEN

CE CAT. I - EN ISO 13688:2013 - EN 14058:2017

Winter jacket in very resistant fabric ideal for "demanding" environments such as building construction; the garment is equipped with a retractable hood, four front pockets and a large internal pocket. Inserts in reflective fabric to increase visibility while not respecting the minimums required by the specific high visibility legislation.

Composition outer part: polyester dobby

g/m² exterior: 240

TPU Membrane: W/P 5.000 mm e MVP 1.000 g/m²/24h.

g/m² Padding: 120

Sizes: S-M-L-XL-XXL-3XL- 4XL-5XL

Colour:

083 grey with back inserts.



Full box: 6 pcs.



04532D

Sizes: M/1-L/2-XL/2-XXL/1 = 6 pcs.



04527B POSH page 7

ESSENTIAL



04099 GREENWICH

CE CAT. I - EN ISO 13688:2013

Synthetic feather technical jacket with two external pockets and a big inside pocket.

Composition outer part: 100% polyester

g/m² exterior: 60

Padding: 100% polyester

g/m² Padding: 200.

Sizes: S-M-L-XL-XXL-3XL

Colour: 040 dark blue inner orange,

Single packed in a poly bag for hanging

Full box: 10 pcs.

**NEW****04100B
FAST****CE CAT. I - EN ISO 13688:2013**

"Fast" winter jacket from the ISSALINE line is made of fabric extremely durable, designed for "demanding" environments such as construction. It presents a simple, essential and professional style. It features an elastic waistband for a better fit and a waterproof taped main zipper. It also features two side pockets with waterproof taped seams and a large pocket inside on the worn right side with Velcro closure.

Outer composition: 100% Taslon Oxford nylon with PU coating

Lining composition: 100% polyester
g/m²: 160 the body and padding, 120 the sleeves.

Sizes: S-M-L-XL-XXL-3XL-4XL-5XL

Colour:
040 blue,
081 anthracite.



box

Full box: 6 pcs.

display

04100D

M/1 - L/2 - XL/2 - XXL/1 = 6 pcs.





3 x 1



**04661
PARKA MASTER PLUS**

CE CAT. I - EN ISO 13688:2013

Waterproof winter 4 IN 1 jacket. Outer shell: waterproof with four bellow pockets, hand warming pocket, concealed hood in collar, badge holder, mobile phone and google zipper pocket, back aeration. Inner detachable: quilted anti cold and tartan-patterned flannel lined, could be worn alone, two outer pockets plus inner one, detachable sleeves.

Composition outer part: 35% polyester, 65% PVC
g/m² exterior: 180

Detachable inner composition: 100% polyester, lined with 100% cotton tartan flannel, velvet collar and piping.

Padding composition: 100% polyester

g/m² Padding: 180

Sizes: S-M-L-XL-XXL-3XL

Colour: 040 blue.

Single packed in a poly bag

Full box: 10 pcs.

FIXED
INNER



**04650A
PARKA NORMAL**

CE CAT. I - EN ISO 13688:2013

Seam and taped, cold- and waterproof jacket with four outer and one inner pocket, inner neck hood, badge holder, phone holder, drawstring waistband.

Composition outer part: 100% PVC coated polyester
g/m² exterior: 180

Padding composition: 100% polyester

g/m² Padding: 180

Sizes: S-M-L-XL-XXL-3XL

Colour: 040 blue.

Single packed in a poly bag

Full box: 10 pcs.

FIXED
INNER



**04650 only on request
NORMAL PARKA WITH HOOD**

CE CAT. I - EN ISO 13688:2013

Waterproof winter jacket with four outer pockets plus inner one, inner collar hood, badge holder, mobile phone pocket, drawstring waistband.

Composition outer part: 100% PVC coated polyester
g/m² exterior: 180

Padding composition: 100% polyester

g/m² Padding: 180

Sizes: S-M-L-XL-XXL-3XL

Colour: 040 blue.

Single packed in a poly bag

Full box: 10 pcs.



DETACHABLE
SLEEVES



**04035
POLAR JACKET**

CE CAT. I - EN ISO 13688:2013

Winter quilted jacket with detachable sleeves, high collar, outer and inner pockets plus two mobile phone pockets, waist adjustable elastic band. Concealed badge holder.

Composition outer part: 80% polyester, 20% cotton.

g/m² exterior: 150

Lining composition: 100% polyester

g/m² Padding: 180

Sizes: M-L-XL-XXL-3XL-4XL-5XL

Colour: 040 blue.

Single packed in a poly bag

Full box: 10 pcs.

**04031
MULTIPOCKETS
VEST**
page 22



4 IN 1



**04554
HEKLA**

CE CAT. I - EN ISO 13688:2013

4 IN 1 jacket with detachable quilted inner shell; outer shell is equipped with three large pockets plus mobile phone pocket, HI-Viz inserts and practical concealed hood.

Composition outer part: 100% polyester pongee pvc coated.

g/m² exterior: 200

Internal composition: 100 % polyester taffeta quilted

g/m² Padding: 120

Sizes: M-L-XL-XXL-3XL

Colour: 083 grey with inserts black.

Single packed in a poly bag

Full box: 10 pcs.



04533B

04805

16-541-EN

8025BP

46205



VEST



8882B CUNNY EXTREME

CE CAT. I - EN ISO 13688:2013

Technical Softshell bodywarmer by Extreme line, with HV inserts, highly breathable membrane, two concealed pockets. The front zip and chest pocket are taped to increase the water resistance of the garment.

Composition: 94% polyester, 6% spandex bonded microfleece

g/m²: 330

Contrast fabric composition: 96% polyester 4% spandex bonded microfleece

g/m²: 350

TPU Membrane: W/P 8.000 mm e MVP 800 g/m²/24 h.

Padding: no

Sizes: S-M-L-XL-XXL-3XL

Colour:

080 grey with inserts black,



Full box: 6 pcs.



8882D

M/1 - L/2 - XL/2 - XXL/1 = 6 pcs.

8884B CLEVER
page 11

8833B HEAVY
page 63

8832B LIGHT
page 63



04509 SNAPPY

CE CAT. I - EN ISO 13688:2013

Softshell bodywarmer with three outer pockets and a practical inner pocket, piping inserts to increase the visibility of the user. It is equipped with a membrane to ensure breathability and waterproofing at the same time.

Composition outer part: 94% polyester, 6% spandex bonded microfleece

g/m² exterior: 310

TPU Membrane: W/P 8.000 mm e MVP 1.000 g/m²/24 h.

Padding: no

Sizes: 040 - 060 XS- S-M-L-XL-XXL-3XL-4XL-5XL

colour: 070 - 080 XS-S-M-L-XL-XXL-3XL

Colour:

040 blue with retro-reflective inserts grey,

060 black with retro-reflective inserts grey,

080 grey with retro-reflective inserts grey,

070 red with retro-reflective inserts grey,

Single packed in a poly bag for hanging

Full box: 10 pcs.



04005 VEGA

CE CAT. I - EN ISO 13688:2013

Directly from sportwear a practical and modern vest made by softshell bonded with soft micro fleece. Excellent fit thanks to stretchable fabric Nylon inserts and reflective piping. Practical front chest pocket.

Composition outer part: 94% polyester 6% spandex bonded microfleece

g/m² exterior: 330

TPU Membrane: W/P 8.000 mm e MVP 800 g/m²/24 h.

Padding: no

Sizes: S-M-L-XL-XXL-3XL

Colour: 060 black with inserts light grey

Single packed in a poly bag for hanging

Full box: 20 pcs.

ISSALINE
BY PIP

VEST



NEW

MADE FROM RECYCLED
PLASTIC BOTTLES**04007
BALI****CE CAT. I - EN ISO 13688:2013**

Sportswear softshell vest. Fabric's composition provides breathability, waterproofing and windproofing, features that working world has learned to appreciate. With three front pockets and two inner ones. Provided with practical roller key holder.

Composition outer part: 94% polyester 6% spandex bonded microfleece

g/m² exterior: 300

TPU Membrane: W/P 8.000 mm e MVP 800 g/m²/24 h.

Padding: no

Sizes: XS-S-M-L-XL-XXL-3XL

Colour: 040 blue whith inserts black,



Single packed in a poly bag for hanging

Full box: 20 pcs.

**04506B
KIDDY****CE CAT. I - EN ISO 13688:2013**

The waterproof and breathable Softshell vest "Kiddy" is made entirely of recycled material, equipped with three front pockets and two large inside pockets. It features a drawstring waist for optimal size adjustment. This vest pairs perfectly with the Boom 9030B, 9032B and 9035B pants. In keeping with its "green" feature, the garment comes in a cardboard package instead of plastic.

Composition: 100% recycled 150D polyester laminated with 100% recycled fleece

g/m²: 320

TPU membrane (recycled): W/P 3.000 mm and MVP 1.000 g/m²/24 h.

Sizes: S-M-L-XL-XXL-3XL-4XL-5XL

Colour:

040 blue black inserts

080 light grey black inserts

081 anthracite grey black inserts.



box

Full box: 20 pcs.



display

04506D

1/S - 2/M - 3/L - 3/XL - 2/XXL - 1/3XL = 12 pcs.



VEST



RESISTANT FABRIC WITH MEMBRANE



04531B WISE
page 14



04532B KEEN
page 14



04527B POSH
page 7



9060B WISE
page 57



VERY RESISTANT FABRIC



04065 OCEAN

CE CAT. I - EN ISO 13688:2013

Padded lightweight bodywarmer, by essential and sportswear cutting. Oxford fabric gives the bodywarmer excellent abrasion resistance and waterproofing, enhancing both work and sport use. Inner band to reinforce pad in the central part of greatest wear.

Composition outer part: polyester oxford PU coated.

g/m² exterior: 230

Internal composition: polyester taffeta

g/m² Padding: 200

Sizes: S-M-L-XL-XXL-3XL-4XL-5XL

Colour:

040 blue,

060 black

210 black/light grey.

Single packed in a poly bag

Full box: 10 pcs.



04533B LUCKY

CE CAT. I - EN ISO 13688:2013

Very resistant fabric vest ideal for "demanding" environments such as construction; the garment has four front pockets and a large internal pocket. Reflective fabric inserts to increase visibility while not respecting the minimums required by the specific high visibility legislation.

Composition outer part: polyester dobby

g/m² exterior: 240

TPU Membrane: W/P 5.000 mm and MVP 1.000 g/m²/24h.

g/m² Padding: 120

Sizes: S-M-L-XL-XXL-3XL-4XL-5XL

Colour:

040 light-blue with inserts blue,

083 grey with inserts black.

box

Full box: 10 pcs.

display

04533D

Sizes: 2/M - 2/L - 2/XL - 2/XXL = 8 pcs.



04031

04822

07139

8025B



VEST



MULTI POCKETS



04027 RING

CE CAT. I - EN ISO 13688:2013

MULTI POCKETS padded bodywarmer (two front pockets, two concealed zip pockets, one mobile phone and two pen pockets. High waterproofing and resistance. Suitable for customizations.

Composition outer part: 100% polyester pongee spalmato PVC.

g/m² exterior: 240

Internal composition: 100% polyester taffeta

g/m² Padding: 160

Sizes: S-M-L-XL-XXL-3XL

Colour: 040 blue.

Single packed in a poly bag

Full box: 20 pcs.



04028 DOGGHY VEST

CE CAT. I - EN ISO 13688:2013

Winter quilted vest, velvet trimming, two outer pockets, snap buttons closure.

Composition outer part: 100% quilted polyester, polyester lining and padding.

g/m² exterior: 240

Internal composition: 100% polyester taffeta

g/m² Padding: 160

Sizes: S-M-L-XL-XXL

Colour: 040 blue.

Single packed in a poly bag

Full box: 20 pcs.

MULTI POCKETS



04031 MULTIPOCKET BODYWARMER

CE CAT. I - EN ISO 13688:2013

Winter quilted bodywarmer, high collar, extended back, armhole with elastic, outer and inner pockets plus one mobile phone pocket. Concealed badge holder.

Composition outer part: 80% polyester, 20% cotton.

g/m² exterior: 150

Internal composition: 100% polyester

g/m² Padding: 180

Sizes: S-M-L-XL-XXL-3XL-4XL-5XL

Colour:

040 blue,

080 grey **only on request**

084 light grey/anthracite.

Single packed in a poly bag

Full box: 20 pcs.

AK9050N

04820

16-368-EN

8830B

44220



ISSALINE
BY PIP



MICROFLEECE



04806 only on request

MEJA

CE CAT. I - EN ISO 13688:2013

Practical micro fleece with long zip closure and pockets. Can be worn alone for mid-seasons and in warmer areas, but also as under wear for winter season. Adjustable elastic waist

Composition: microfleece 100% polyester.

g/m²: 230

Sizes: S-M-L-XL-XXL-3XL

Colour:

040 blue,

060 black

080 grey.

Single packed in a poly bag

Full box: 20 pcs.

MICROFLEECE



04805 MONVISO

CE CAT. I - EN ISO 13688:2013

Monviso is a practical half zip microfleece. Can be worn alone for mid-seasons and in warmer areas, but also as garment for winter season. Adjustable elastic waist.

Composition: microfleece 100% polyester.

g/m²: 230

Sizes: S-M-L-XL-XXL-3XL

Colour:

040 blue,

060 black

080 grey.

Single packed in a poly bag

Full box: 20 pcs.



04055 EVERYTIME JACKET

CE CAT. I - EN ISO 13688:2013

Fleece jacket with antipilling treatment, outer zippered pockets and one large inner pocket, waterproof fabric inserts on shoulders and outer forearms. Drawstring bottom.

Composition: 100% polyester.

g/m²: 280

Sizes: S-M-L-XL-XXL

Colour:

040 blue.

Single packed in a poly bag

Full box: 20 pcs.

POLAR 450 g/m²



04054 OREGON

CE CAT. I - EN ISO 13688:2013

Oregon is an heavy weight (450 g/m²) sweatshirt ideal for cooler climates, otherwise, can be used in temperate zones alternatively to a traditional jacket. A central zip and three frontal pockets give to Oregon a modern look and multiple use.

Composition outer part: 100% polyester

g/m²: 450

Padding: no

Sizes: S-M-L-XL-XXL

Colour: 040 blue with inserts light grey

Single packed in a poly bag for hanging

Full box: 10 pcs.

ISSALINE
BY PIP

VERSATILE

**04807
ORTIGARA**

CE CAT. I - EN ISO 13688:2013

Microfleece with 4 pockets, fixed hood and elasticated inserts for better comfort. A light and warm garment at the same time.

Composition outer part: 100% polyester anti-pilling microfleece.**g/m²:** 160 **Padding:** no**Sizes:** S-M-L-XL-XXL-3XL**Colour:** 040 blue with inserts orange, 060 black with inserts orange, 081 grey with inserts orange,Single packed in a poly bag for hanging **Full box:** 10 pcs.**8881B
REVENGE EXTREME**

CE CAT. I - EN ISO 13688:2013

Knitted jacket of Extreme line with anti-abrasion inserts, two front pockets, one chest document pocket and two large inner pockets. The garment can be combined with Extreme line items or even with other trousers. The lightness and softness allows it to be used both as an outer garment and under a vest or winter jacket.

Main composition: 100% knitted polyester**Composition inserts:** 97% polyester, 3% spandex **g/m²:** 270 **Padding:** no**Sizes:** S-M-L-XL-XXL-3XL-4XL-5XL**Colour:** 040 blue with inserts black, 080 grey with inserts black,box
Full box: 6 pcs.

display

8881D

M/1 - L/2 - XL/2 - XXL/1 = 6 pcs.

250-87-0020-EN

16-541-EN

8025BP

06893R



**04820
VERENA**

CE CAT. I - EN ISO 13688:2013

Half-zip sweatshirt with elastic rib on cuffs and bottom. Stabilized fabric to prevent shrinkage.

Composition: 65% polyester 35% cotton

g/m²: 280

Sizes: S-M-L-XL-XXL-3XL

Colour:

040 blue

060 black

070 red

080 grey.

Single packed in a poly bag

Full box: 20 pcs.



**04822
PELMO**

CE CAT. I - EN ISO 13688:2013

Sweatshirt with long zip and two large front pockets, cuffs and bottom with elastic rib. Stabilized fabric to avoid shrinkage

Composition: 65% polyester 35% cotton

g/m²: 280

Sizes: S-M-L-XL-XXL-3XL

Colour:

040 blue

060 black

080 grey.

Single packed in a poly bag

Full box: 20 pcs.



**04819 only on request
FALORIA**

CE CAT. I - EN ISO 13688:2013

Round neck sweatshirt, cuffs and bottom with elastic rib. Stabilized fabric to avoid shrinkage.

Composition: 65% polyester 35% cotton

g/m²: 280

Sizes: S-M-L-XL-XXL-3XL

Colour:

040 blue

060 black

080 grey.

Single packed in a poly bag

Full box: 20 pcs.



**04824
ANTELAO**

CE CAT. I - EN ISO 13688:2013

Sweatshirt with long zip, hood, two front pockets, cuffs and bottom with elasticated rib. Stabilized fabric to prevent shrinkage.

Composition: 65% polyester 35% cotton

g/m²: 280

Sizes: S-M-L-XL-XXL-3XL

Colour:

040 blue

060 black

080 grey.

Single packed in a poly bag

Full box: 20 pcs.



ISSALINE
BY PIPEXTREME
SWEATSHIRT8883B
TUBE

CE CAT. I - EN ISO 13688:2013

Technical sweatshirt from the Extreme line with hood, two front pockets, a document holder on the chest and two large internal pockets. The garment can be combined with products from the Extreme line or also with other trousers. The sweatshirt also has the characteristic of using recycled polyester which, together with the cotton and the cardboard packaging, make it a product that can be appreciated by those looking for "green" solutions.

Composition: 65% recycled polyester, 35% cotton
g/m²: 280

Sizes: S-M-L-XL-XXL-3XL-4XL-5XL

Colour:

040 blue with black inserts,
081 anthracite grey with black inserts,



box

Full box: 6 pcs.

display

8883D

M/1 - L/2 - XL/2 - XXL/1 = 6 box

MADE FROM RECYCLED
PLASTIC BOTTLES



**04379
BASEBALL CUP**

ISSALINE cap with visor.

Composition: 100% cotton

g/m²: 80

Sizes: one size

Colour: 060 black

single packed in a poly bag

Full box: 10 pcs.



**00995
BELT**

Two-color reversible belt with metal buckle.

Composition strap: 100% cotton

Sizes: one size

Colour:

083 grey/black,
150 blue/beige

single packed in a poly bag

Full box: 50 pcs.



**04380
CASQUETTE Thinsulate®**

Winter cap.

Composition: acrylic with Thinsulate®

inner lining

g/m²: 160

Sizes: one size

Colour:

060 black,
080 grey.

single packed in a poly bag

Full box: 10 pcs.



**00990
KNEEPADS**

Suitable for all the preset garments.
Dimensions: 15,5x26 cm.

Composition: 100% EVA

Sizes: only adjustable.

Colour: grey

5 pa.

Full box: 20 prs.



**04370
PADDED CAP**

Winter padded cap with ear flaps and back elastic band.

Composition: polyester PVC coated,

polyester padding, nylon lining

Sizes: one size

Colour: 040 blue.

single packed in a poly bag

Full box: 10 pcs.



**00980
TOM KNEEPADS**

Ergonomic knee pad to be applied externally by velcro closure; Pad designed to meet the needs of those who are forced to work for a long time kneeling (e.g. tilers). Supplied with handy blister.

Sizes: only adjustable.

Colour: black

box

Full box: 10 prs.





FOR EXTRAORDINARY WORKERS

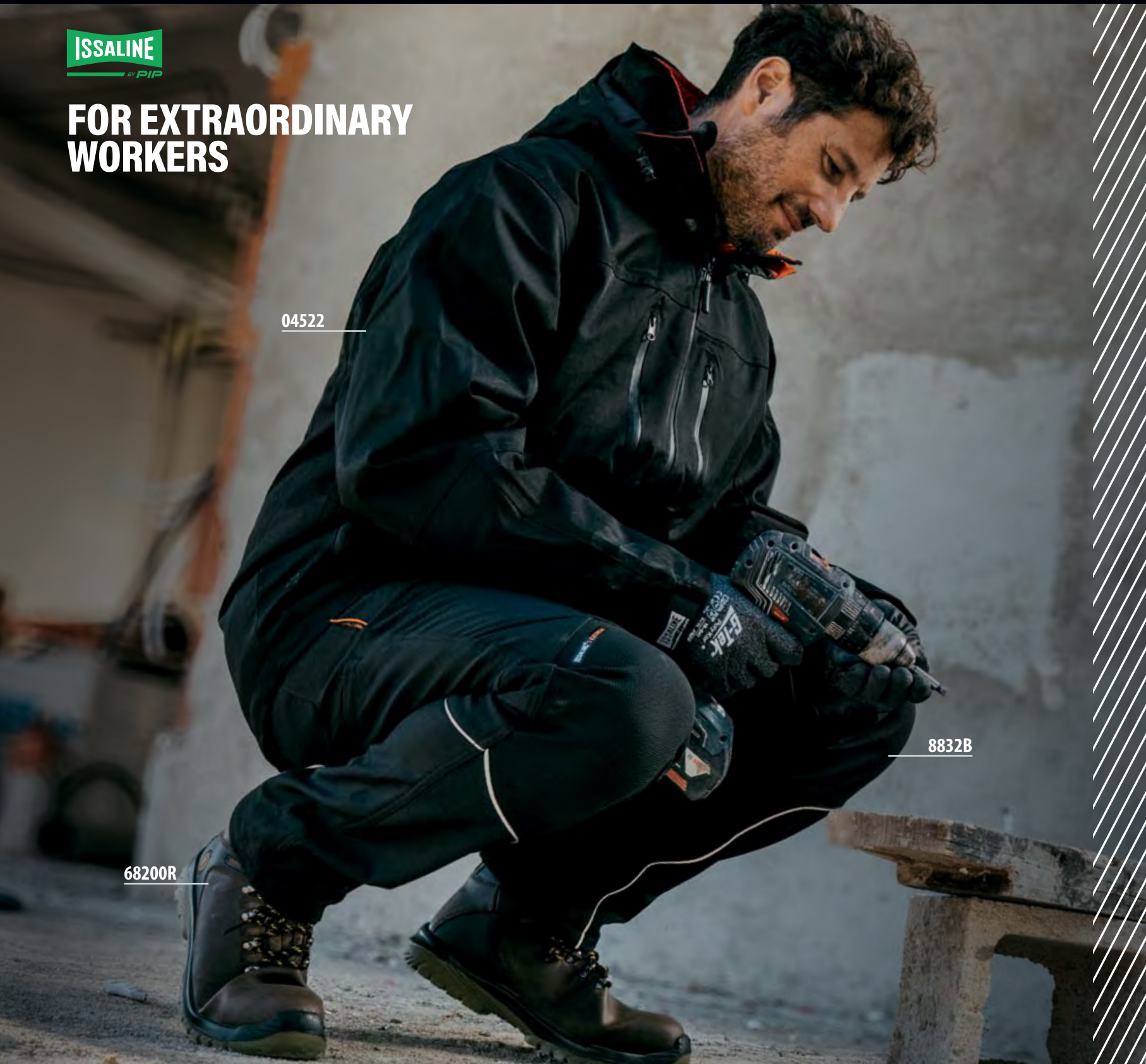

04522

8832B

68200R

WINTER TROUSERS SELECTION



8832B LIGHT EXTREME
page 63



8833B HEAVY EXTREME
page 63



8032 FUSTIAN
page 37



8730WB WINTER BICOLOR STRETCH
page 59



8731WB WINTER MONOCOLOR STRETCH
page 59



8532 AV FUSTIAN
page 80



YOUR WORK MATTERS

We are proud to present a wide range of options to meet the needs of professionals in a variety of fields. Below, you can explore our lines of workwear in stretch cotton, each with features unique to offer comfort and protection in every situation. Regardless of your profession or field, our catalog of workwear offers options that will meet your needs.

We are confident that you will find the perfect workwear for working safely and comfortable and always stylish. Choose the line that best suits your needs and rely on our quality, experience and dedication to your working success.

250-94-0120-EN

263-NP220

8845B

16-368-EN

8830B

46300



EUROPA

Europa line: Our Europa line is synonymous with durability and comfort. Made from 100% cotton, this range of workwear is ideal for those seeking strength and durability. The Europa line garments are designed to offer maximum protection in demanding work environments.

Key features:

- 100% cotton fabric.
- Traditional style design.
- Ideal for industrial and blue-collar environments.



SHOT

Shot line: Garments in SHOT line are made of 100% cotton fabric, by far the absolutely the best material for breathability and healthiness. The grammage of 250 g/m² allows the garment to be used all year round, especially during the summer season, solving the problems typical of garments containing polyester or synthetic fabrics.

Key features:

- 100% cotton fabric.
- Traditional style design.
- Versatile clothing for multiple situations.



EASYSTRETCH START STRETCH

Easy Stretch and Start trousers: Our work trousers are the ideal choice for those who want maximum comfort and elasticity during working day. For those who want practical and technical clothing. Equipped with multi-purpose pockets and retro-reflective inserts. The technical trousers, in addition to a practical pocket mobile phone, allow the insertion of knee pads.

Key features:

- Stretch fabric.
- Fit.
- Clothing equipped with multifunctional pockets.





8030 EUROPA
page 37



8030P EUROPA WITH LARGE POCKET
page 37



8032 FUSTIAN
page 37



8630 PAINTER
page 39



8030T EUROPA TOP
page 41



8031 SUMMER
page 37



8028 RAPTOR
page 41



8930 SHOT
page 42



5030 M-PRO
page 85



8430N AV
page 79



8438 AV LIGHT
page 79



8532 AV FUSTIAN
page 80

32 STRETCH PANTS



8038B EASYSTRETCH
page 44



8038BL LADY EASYSTRETCH
page 44



8036B START
page 45



8036BW START HEAVY
page 45



9030B STRETCH BOOM
page 50



8730B BICOLOR STRETCH
page 56



8730WB WINTER BICOLOR STRETCH
page 59



8731B MONOCOLOR STRETCH
page 56



8731WB WINTER MONOCOLOR STRETCH
page 59



8830B STRETCH EXTREME
page 62

8838B STRETCH EXTREME
page 47

8738 STRETCH ON
page 46

8025B JEST STRETCH
page 47

8025BP JEST STRETCH
page 47

11 SOFTSHELL PANTS



9060B WISE
page 57

9032B BOOM
page 53

9035B BOOM
page 51

8833B HEAVY EXTREME
page 63

8832B LIGHT EXTREME
page 63

8837B EXTREME LIGHT
SUMMER 2023
page 63

8450B AV LIGHT
page 83

10 WINTER PANTS



8032 FUSTIAN
page 37

8036BW START HEAVY
page 45

8730WB WINTER BICOLOR STRETCH
page 59

8731WB WINTER MONOCOLOR STRETCH
page 59

8833B HEAVY EXTREME
page 63

8832B LIGHT EXTREME
page 63

8532 HV FUSTIAN
page 80



EUROPA WORKWEAR



8045 EUROPA SHORT JACKET

CE CAT. I - EN ISO 13688:2013

Two stitched pockets on chest with flap and button. Fastener with flap covered buttons. Cuffs with button. Shirt collar.

Composition: 100% cotton

g/m²: 250

Sizes: S-M-L-XL-XXL-3XL

Colour: 040 blue,

Single packed in a poly bag

Full box: 10 pcs.



8050 EUROPA JACKET

CE CAT. I - EN ISO 13688:2013

Two stitched pockets and a little stitched chest pocket. Fastening with buttons covered by flap, removable elastic on cuffs. Sewn half-belt to avoid entanglement. Shirt collar.

Composition: 100% cotton

g/m²: 250

Sizes: S-M-L-XL-XXL-3XL

Colour: 040 blue,

Single packed in a poly bag

Full box: 20 pcs.



8035 EUROPA BIB TROUSERS

CE CAT. I - EN ISO 13688:2013

Stitched side pockets, stitched back pocket with button and rule pocket. Chest pocket with zip. Side opening with button to easier wearing. Adjustable braces with plastic buckl.

Composition: 100% cotton

g/m²: 250

Sizes: S-M-L-XL-XXL-3XL

Colour: 040 blue,

Single packed in a poly bag

Full box: 20 pcs.



8070 EUROPA COVERALL

CE CAT. I - EN ISO 13688:2013

2 stitched pockets and 2 stitched chest little pockets with flap and button. Back pocket with button and rule pocket. Elastic on the rear part of waist. Removable elastic on cuffs. Fastening with zip in nylon covered by flap. Shirt collar.

Composition: 100% cotton

g/m²: 250

Sizes: S-M-L-XL-XXL-3XL

Colour:

020 green,

040 blue,

042 royal blue **only on request**

Single packed in a poly bag

Full box: 10 pcs.



ISSALINE
BY PIP**8030**
EUROPA TROUSERS**CE CAT. I - EN ISO 13688:2013**

Front slanted welt pockets, back stitched pocket with button, rule pocket. Belt loops on waist with elastic on the back. Flap with covered buttons.

Composition: 100% cotton**g/m²:** 250**Size 020 080:** XS-S-M-L-XL-XXL-3XL**Size 040:** XS-S-M-L-XL-XXL-3XL-4XL-5XL**Colour:**020 green, **only on request**

040 blue,

042 royal blue, **only on request**

080 grey

Single packed in a poly bag

Full box: 20 pcs.**LARGE POCKET****8030P**
EUROPA TROUSERS WITH LARGE POCKET**CE CAT. I - EN ISO 13688:2013**

Trousers with elastic waistband, side pocket with badge holder, two front and one rear pockets, mobile phone and rule holder pocket. Large side pocket. Flap with zipper closure and contrast stitchings.

Composition: 100% cotton**g/m²:** 250**Sizes:** XS-S-M-L-XL-XXL-3XL-4XL-5XL**Colour:** 040 blue,

Single packed in a poly bag

Full box: 20 pcs.**8031**
SUMMER TROUSERS**CE CAT. I - EN ISO 13688:2013**

Two slanted welt pockets. Back pocket and two large side pockets with flap and velcro. Belt loops on waist with elastic on the back.

Composition: 100% cotton**g/m²:** 210**Sizes:** XS-S-M-L-XL-XXL-3XL**Colour:** 040 blue, 080 grey**Full box:** 20 pcs.**LIGHT****8034**
SUMMER SHORT TROUSERS**CE CAT. I - EN ISO 13688:2013**

Two slanted welt pockets. Back pocket and two large side pockets with flap and velcro. Belt loops on waist with elastic on the back.

Composition: 100% cotton**g/m²:** 210**Sizes:** S-M-L-XL-XXL**Colour:** 040 blue,

Single packed in a poly bag

Full box: 20 pcs.**FUSTIAN****8032**
FUSTIAN TROUSERS**CE CAT. I - EN ISO 13688:2013**

Elastic waistband, front slanted pockets, back patch pocket with button and rule holder pocket.

Composition: 100% fustian cotton**g/m²:** 350**Sizes:** S-M-L-XL-XXL**Colour:** 040 blue,

Single packed in a poly bag

Full box: 20 pcs.



EUROPA WORKWEAR



8100 EUROPA COAT

CE CAT. I - EN ISO 13688:2013

Two stitched pockets and a little stitched chest pocket. Removable elastic on cuffs. Sewn half-belt. Shirt collar. Fastening with buttons covered by flap.

Composition: 100% cotton
g/m²: 250

Sizes: S-M-L-XL-XXL-3XL

Colour: 040 blue,

Single packed in a poly bag

Full box: 20 pcs.



08100 MAN COAT

CE CAT. I - EN ISO 13688:2013

Two stitched pockets and little pocket on chest, buttons with flap. Sewn half-belt. Shirt collar. Removable elastic on cuffs.

Composition: 65% polyester terital, 35% cotton
g/m²: 155

Sizes: S-M-L-XL-XXL

Colour:

020 green **only on request**

040 blue,

050 white,

060 black

Single packed in a poly bag

Full box: 20 pcs.



08105 WOMAN COAT

CE CAT. I - EN ISO 13688:2013

Two stitched pockets and little chest pocket. Women shape and row of buttons, covered buttons, darts and sewn half-belt.

Composition: 65% polyester terital, 35% cotton
g/m²: 155

Sizes: S-M-L-XL-XXL (female sizes are one size smaller of female ones).

Colour:

040 blue,

050 white,

Single packed in a poly bag

Full box: 20 pcs.



7070 BICOLOR OVERALL

CE CAT. I - EN ISO 13688:2013

Two-tone suit with two front pockets at chest height, one side pocket, one back pocket, two waist pockets and two pass-through pockets (useful if you use the garment over another trousers). Elastic waist for greater comfort and removable elastic at the wrists.

Composition: 60% cotton, 40% polyester
g/m²: 220

Sizes: S-M-L-XL-XXL-3XL

Colour:

027 green/black,

083 grey/black.

Full box: 10 pcs.





**8630
PAINTER TROUSERS**

CE CAT. 1 - EN ISO 13688:2013

Front slanted welt pockets, side pocket with flap and velcro, side rule pocket, back pocket with flap and velcro. Belt loops on waist with elastic on the back. Flap with zip.

Composition: cotton 100%

g/m²: 220

Sizes: S-M-L-XL-XXL

Colour: 050 white

Full box: 20 pcs.



**8730B
STRETCH**
page 56



**8734B
STRETCH**
page 59



**08182
RAPALLO**
page 67



**08185
CAPRI**
page 66



**8180
SORRENTO**
page 66



16-319-EN

35060N



08125
SHORT-SLEEVED
SANITARY
WHITE

only on request

Short-sleeved ranglan tunic. Closed v-neck. Slits on both hips. 1 upper pocket and 2 lower pockets.

Composition: 65% polyester, 35% cotton
g/m²: 190

Sizes: XS-S-M-L-XL-XXL-3XL

Colour: 050 white,

 Single packed in a poly bag

Full box: 25 pcs.



08120
PANTS WHITE
SANITARY

only on request

Elasticized waist pants with front welt patch pockets.

Composition: 65% polyester, 35% cotton
g/m²: 190

Sizes: XS-S-M-L-XL-XXL-3XL

Colour: 050 white,

 Single packed in a poly bag

Full box: 25 pcs.



08115
UNIFORM FOR SANITARY

only on request

White sanitary full set (set with vest and trousers). Short sleeved vest in ranglan. Closed V-neck. Slits on both sides. 1 chest pocket and 2 lower pockets.

Elasticated waist trousers with front pockets with thread connection.

Composition: 65% polyester, 35% cotton
g/m²: 190

Sizes: XS-S-M-L-XL-XXL-3XL

Colour:
050 white,
110 celeste

 Single packed in a poly bag

Full box: 14 pcs.



**TWO LARGE POCKETS****8030T
EUROPE TOP TROUSERS****CE CAT. I - EN ISO 13688:2013**

Trousers with elastic waistband, side pocket with badge holder, two front and one rear pockets, mobile phone and rule holder pocket. Flap with zipper closure and contrast stitchings.

Composition: 100% cotton**g/m²:** 245**Sizes:** XS-S-M-L-XL-XXL-3XL**Colour:** 040 blue**Full box:** 10 pcs.**CARGO STYLE****8028
RAPTOR****CE CAT. I - EN ISO 13688:2013**

"Cargo" pants, with many zippers and pockets.

Composition:

100% canvas cotton

g/m²: 215**Sizes:** S-M-L-XL-XXL-3XL**Colour:** 020 green.

box

Full box: 10 pcs.

display

8028D**Sizes:** S/1 - M/2 - L/3 - XL/3 - XXL/2 - 3XL/1
= 12 pcs.**CARGO STYLE****8040
SHORT TROUSERS RAPTOR****CE CAT. I - EN ISO 13688:2013**

"Cargo" pants, with many zippers and pockets.

Composition: 100% cotton**g/m²:** 215**Sizes:** S-M-L-XL-XXL-3XL**Colour:** 020 green

box

Full box: 10 pcs.

display

8040D**Sizes:** S/1 - M/2 - L/3 - XL/3 - XXL/2 - 3XL/1 = 12 pcs.

04824

41-1415-EN

8030T

35078



SHOT WORKWEAR

SHOT line clothing are made of 100% cotton, by far the best fabric for breathability and health. The 250 g/m² basic weight allows clothing to be used all year around, especially during summertime by solving the typical problems of clothing containing polyester or synthetic fabrics. Each item is finished with coloured inserts and practical multipurpose pockets. Technical trousers, as well as a practical mobile phone pocket, allow knee pads' inserts.



8945 SHOT JACKET

CE CAT. I - EN ISO 13688:2013

With central zip, two chest pockets and two welt pockets. Adjustable waist through buttons. Foldaway badge holder.

Composition: 100% cotton

g/m²: 250

Sizes: S-M-L-XL-XXL-3XL

Colour:

040 blue with black inserts,
080 grey with black inserts.



Single packed in a poly bag for hanging

Full box: 10 pcs.



8935 SHOT BIB TROUSERS

CE CAT. I - EN ISO 13688:2013

Two front pockets, one large side pocket, mobile phone pocket and rule pocket. Two rear pockets and one large bib pocket. Elastic waistband, adjustable braces and badge holder.

Composition: 100% cotton

g/m²: 245

Sizes: S-M-L-XL-XXL-3XL

Colour:

080 grey with black inserts.



Single packed in a poly bag for hanging

Full box: 10 pcs.



8930 SHOT TROUSERS

CE CAT. I - EN ISO 13688:2013

100% cotton fabric 250 g/m². With rule pocket, large side pockets, foldaway mobile's holder and knee-band. The elastic on waist and its shape make it very comfortable. With foldaway badge holder.

Composition: 100% cotton

g/m²: 250

Sizes: S-M-L-XL-XXL-3XL

Colour:

040 blue with black inserts,
080 grey with black inserts.



Single packed in a poly bag for hanging

Full box: 10 pcs.



8970 SHOT COVERALL

CE CAT. I - EN ISO 13688:2013

Central zipper, two chest pockets and two front welt pockets. Waist adjustment through buttons. Foldaway badge holder.

Composition: 100% cotton

g/m²: 245

Sizes: S-M-L-XL-XXL-3XL

Colour:

080 grey with black inserts.



Single packed in a poly bag for hanging

Full box: 10 pcs.



THE STRETCH SPECIALIST

Seventeen years ago we introduced the STRETCH concept to the world of workwear. It seemed an impossible challenge, but the more than 6 million garments sold have proven otherwise. From 2017 with the STRETCH EXTREME line and in 2021 and 2022 with the START and BOOM lines, thanks to technical solutions and renewed fit and design, ISSALINE aims to consolidate its leadership in workwear.

2006

8730
Stretch beige



2007

8025
Jeans Stretch



2008

8730W
winter



2010

8170
Polo Stretch



2011

8731
Stretch



2014

8033
Jeans Miner



2015

8738
Stretch On



2016

ISSALINE.it
Stretch



2017

8038B
Easystretch



2017

8830B
Stretch EXTREME



2018

8834B
Stretch EXTREME



2019

8830B
Stretch EXTREME



2020

8838B 040
Jeans Stretch EXTREME



2020

8189B
Polo Portofino



2020

8836B
Light Stretch EXTREME



2021

8036B
Start Stretch



2022

46200
44400
STRETCH EXTREME



2023

9032B
BOOM



2024

8016B
PEAKY





EASYSTRETCH WORKWEAR



8038B boxed version in stock in Italy EASYSTRETCH

CE CAT. I - EN ISO 13688:2013

Trousers 100% stretch cotton with elastic waistband, two side pockets and two back pockets. Flap with zipper closure.

Composition: 98% cotton, 2% elasthan,

g/m²: 260

Sizes: XS-S-M-L-XL-XXL-3XL

Colour: 040 blue, 060 black, 080 grey



Full box: 10 pcs.



8038D

Sizes: S/1 - M/2 - L/3 - XL/3 - XXL/2 - 3XL/1 = 12 pcs.



8038 only on request - without boxes and different colors EASYSTRETCH

CE CAT. I - EN ISO 13688:2013

Trousers 100% stretch cotton with elastic waistband, two side pockets and two back pockets. Flap with zipper closure.

Composition: 98% cotton, 2% elasthan,

g/m²: 260

Sizes: XS-S-M-L-XL-XXL-3XL

Colour: 020 green, 025 beige, 040 royal blue, 050 white, 060 black, 080 grey



Single packed in a poly bag

Full box: 10 pcs.

CONFORMED WOMAN

8038BL LADY EASYSTRETCH

CE CAT. I - EN ISO 13688:2013

stretch cotton with elastic waistband, two side pockets and two back pockets. Flap with zipper closure.

Composition: 98% cotton, 2% spandex

g/m²: 260

Sizes: conformed woman S-M-L-XL-XXL

Colour: 040 blue



Full box: 10 pcs.



8189L POLO PORTOFINO LADY

page 66



8038 only on request EASYSTRETCH AV

EN ISO 13688:2013

EN ISO 20471:2013 + A1: 2016 CLASE 1

HI-VI trousers in stretch cotton, with two side pockets, two front pockets and two rear pockets, with reflective bands. Zip fastener.

Blue composition: 97% cotton, 3% elasthan

g/m²: 260

Yellow composition: 61% cotton, 39% polyester,

g/m²: 255

Sizes: XS-S-M-L-XL-XXL-3XL

Colour: 052 blue/yellow AV

Full box: 10 pcs.



ISSALINE
BY PIPSTRETCH
START

04094B

68200R

8036B
START260 g/m²

CE CAT. I - EN ISO 13688:2013

Stretch trousers with high visibility inserts, two front pockets, two back pockets covered by flaps, a side pocket with bellows and a rule holder pocket. Waistband improves the natural comfort of stretch fabric. Packed in box.

Composition: 97% cotton, 3% spandex**g/m²:** 260**Sizes:** XS-S-M-L-XL-XXL-3XL-4XL-5XL**Colour:**

040 blue with orange stitchings,

078 light grey with slightly darker grey stitchings,

081 anthracite with slightly lighter grey stitch.



box

Full box: 10 pcs.

display

8036D

Sizes: S/1 - M/2 - L/3 - XL/3 - XXL/2 - 3XL/1 = 12 pcs.8041B
START SHORT TROUSERS

CE CAT. I - EN ISO 13688:2013

Same features as the trousers.

Composition: 97% cotton, 3% spandex**g/m²:** 260**Sizes:** S-M-L-XL-XXL-3XL**Colour:**

040 blue with orange stitchings,

078 light grey with slightly darker grey stitchings,

081 anthracite with slightly lighter grey stitch.



box

Full box: 10 pcs.

display

8041D

Sizes: S/1 - M/2 - L/3 - XL/3 - XXL/2 - 3XL/1 = 12 pcs.320 g/m²8036BW
START HEAVY

CE CAT. I - EN ISO 13688:2013

Stretch trousers with retro-reflective inserts, equipped with two front pockets, two back pockets covered by flaps, a side pocket with bellows and a rule holder pocket. Elastic waistband enhances the natural comfort of the stretch fabric. In brief, these trousers are same as 8036B version but with an heavier weight making them ideal for the winter months if required.

Composition: 97% cotton, 3% spandex**g/m²:** 320**Sizes:** XS-S-M-L-XL-XXL-3XL-4XL-5XL**Colour:** 040 blue with orange stitchings, 078 light grey with slightly darker grey stitchings, 081 anthracite with slightly lighter grey stitch.

box

Full box: 10 pcs.

display

8036DW

Sizes: S/1 - M/2 - L/3 - XL/3 - XXL/2 - 3XL/1 = 12 pcs.



STRETCH ON



8738 STRETCH ON

CE CAT. I - EN ISO 13688:2013

Multipocket 100% canvas cotton trousers. With stretch fabric inserts in the most stressed areas for better workers' comfort. Adjustable size with elastic and buttons. Supplied in paperboard box.

Composition: 100% canvas cotton with inserts in stretch.

g/m²: 250

Sizes: S-M-L-XL-XXL-3XL

Colour: 049 blue avio blue inserts grey anthracite,

080 grey inserts grey anthracite,

200 green inserts grey anthracite **only on request**



Full box: 10 pcs.



8738D

Sizes: S/1 - M/2 - L/3 - XL/3 - XXL/2 - 3XL/1 = 12 pcs.

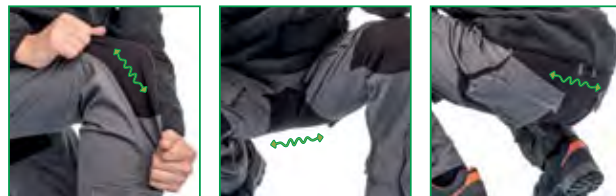

8023B **only on request** BERMUDA JEANS STRETCH LIGHT

CE CAT. I - EN ISO 13688:2013

Thanks to stretch fabric and weight, this jeans is very comfortable; you can wear it all year round, but it is excellent during the warmer months. Frontal pockets and contrast reinforced fabric. Mobile phone pocket and rule pocket. Flap

Composition: 98% cotton, 2% spandex

g/m²: 280 after washing

Sizes: S-M-L-XL-XXL-3XL

Colour: 040 blue

Full box: 12 pcs.



ISSALINE
CLOTHINGJEANS
STRETCH

THE PIONEER

8025B
JEANS JEST STRETCH

CE CAT. I - EN ISO 13688:2013

Stretch cotton fashion jeans with stone washed treatment. Front and back welt mobile phone pockets. Fly with button closure.

Composition: 75% cotton, 24% polyester, 1% spandex

g/m²: 450 after washing

Sizes: S-M-L-XL-XXL-3XL-4XL-5XL

Colour: 040 blue



Full box: 10 pcs.



8025D

Sizes: S/1 - M/2 - L/3 - XL/3 - XXL/2 - 3XL/1 = 12 pcs.



NEW

8025BP
JEANS STRETCH
MULTIPOCKETS

CE CAT. I - EN ISO 13688:2013

Stretch jeans, with stone washed treatment. Mobile phone front stash pocket and ruler rear pocket, two compartment large side pocket with flap and zip fastening. Flap with button closure.

Composition: 75% cotton, 24% polyester, 1% spandex

g/m²: 450 after washing

Sizes: S-M-L-XL-XXL-3XL-4XL-5XL

Colour: 040 blue



Full box: 10 pcs.



8025BPD

Sizes: S/1 - M/2 - L/3 - XL/3 - XXL/2 - 3XL/1 = 12 pcs.

8838B
JEANS EXTREME

CE CAT. I - EN ISO 13688:2013

Athletic fit jeans with reinforcements in antiabrasion cordura-like fabric that, joined with the back reinforcement, further improve the strenght of this garment. With four pockets, plus both foldaway rule holder and mobile phone pockets.

Composition: 98% cotton, 2% spandex

g/m²: 320 after washing

Sizes: S-M-L-XL-XXL-3XL

Colour: 040 blue with black inserts



Full box: 10 pcs.



8838D

Sizes: S/1 - M/2 - L/3 - XL/3 - XXL/2 - 3XL/1 = 12 pcs.

8839B
JEANS BERMUDA EXTREME

CE CAT. I - EN ISO 13688:2013

Athletic fit short jeans with anti abrasion Cordura like fabric reinforcements, that, together with back reinforcement, improves robustness. With four pockets, plus a mobile phone pocket and a rule holder pocket, both concealed.

Composition: 98% cotton, 2% spandex

g/m²: 280 before washing

Sizes: S-M-L-XL-XXL-3XL

Colour: 040 blue with black inserts,



Full box: 10 pcs.



8839D

Sizes: S/1 - M/2 - L/3 - XL/3 - XXL/2 - 3XL/1 = 12 pcs.





PEAKY STRETCH

modern
style

SUPER STRETCH



SUPER
COMFORT

8016B PEAKY STRETCH

CE CAT. I - EN ISO 13688:2013

Soft and comfortable trousers. Elastic at the waist and bottom at the ankles. Two slanted welt side pockets and two rear pockets.

Composition: 97% cotton 3% spandex

g/m²: 250

Sizes: S-M-L-XL-XXL-3XL-4XL-5XL

Colour:

020 olive green

040 blue



Full box: 10 pcs.



8016D

Sizes: S/1 - M/2 - L/3 - XL/3 - XXL/2 - 3XL/1 = 12 pcs.



ISSALINE
BY PIP

STRETCH BOOM

Our ISSALINE BOOM line is dedicated to people who seek a combination of style, comfort and elasticity. These garments are designed with attention to details and are perfect for people who want a professional look without sacrificing comfort.

Key features:

- Superior quality stretch fabric.
- Modern and elegant design.
- Perfect for professionals who require style in the workplace.

263-NP222

8810B

17366

9032B

46200



9045B STRETCH BOOM JACKET

CE CAT. I - EN ISO 13688:2013

Work jacket in stretch mixed fabric with four front pockets; covered front zipper, waist adjustment. Three reflective pipings offer visibility in cases of poor visibility (where an EN20471 certified product is not required).

Composition: 60% cotton, 37% polyester, 3% lycra

g/m²: 260

Sizes: S-M-L-XL-XXL-3XL-4XL-5XL

Colour:

040 blue/inserts black,
080 grey/inserts black,
081 anthracite/inserts black.



Full box: 10 pcs.



9030B STRETCH BOOM TROUSERS

CE CAT. I - EN ISO 13688:2013

Work trousers in mixed stretch fabric with two front pockets, a large pocket on the left leg, a retractable front telephone pocket, two rear pockets and a meter pocket. Other features of the garment are the elastic waistband which together with the stretch fabric enhance the comfort of the trousers while the rear reinforcement and the knee pads increase its resistance. Three reflective pipings offer visibility in cases of poor visibility (where an EN20471 certified product is not required).

Composition: 60% cotton, 37% polyester, 3% lycra

g/m²: 260

Sizes: S-M-L-XL-XXL-3XL-4XL-5XL

Colour:

040 blue/inserts black,
080 grey/inserts black,
081 anthracite/inserts black.



Full box: 10 pcs.

9034B STRETCH BOOM BERMUDA

CE CAT. I - EN ISO 13688:2013

Work Bermuda shorts in mixed stretch fabric with two front pockets, a large pocket on the left leg, a retractable front phone pocket, two rear pockets and a meter pocket. Other features of the garment are the elastic waistband which together with the stretch fabric enhance the comfort of the trousers while the back reinforcement increases its resistance. Three reflective pipings offer visibility in cases of poor visibility (where an EN20471 certified product is not required).

Composition: 60% cotton, 37% polyester, 3% lycra

g/m²: 260

Sizes: S-M-L-XL-XXL-3XL-4XL-5XL

Colour:

040 blue/inserts black,
080 grey/inserts black,
081 anthracite/inserts black.



Full box: 10 pcs.





BELT INCLUDED
210 g/m²

4 seasons



9035B
TROUSERS BOOM 4 SEASONS
(4 WAY STRETCH)

CE CAT. I - EN ISO 13688:2013

4-way stretch softshell trousers which, thanks to their intermediate weight, allow the use throughout all the year. The garment has a knee pad holder, ruler pocket, two back pockets and a large side pocket. Two side inserts in stretch fabric increase comfort at the waist while the high visibility inserts offer a minimum of night visibility. Supplied with belt.

Composition: 92% polyester 8% spandex with dual function treatment: quick drying of water and expulsion of perspiration through the fabric - "3M SCOTHGARD treatment"

g/m²: 210

Sizes: S-M-L-XL-XXL-3XL-4XL-5XL

Colour:

081 anthracite grey



box

Full box: 10 pcs.



display

9035D

S/1 - M/2 - L/3 - XL/3 - XXL/2 - 3XL /1 = 12 box



Removable belt.



Pockets with Velcro closure and retro-reflective piping.



Kneepad pockets.



Welt pockets.



Cell phone pocket.

250-87-0020-EN

263-NP330-EN

04508B

16-854-EN

9035B

46300





BELT INCLUDED
115 g/m²

9032B
BOOM SOFTSHELL LIGHT TROUSERS

CE CAT. I - EN ISO 13688:2013

Summer trousers in lightweight Stretch softshell 4-WAY fabric, equipped with knee pad holder, mobile phone pocket, two front pockets, ruler pocket, two rear pockets and a side pocket. Two side inserts in stretch fabric increase comfort at the waist while the high-visibility inserts offer a minimum of visibility at night. The width of the leg bottom can be regulated by an elastic, which can easily be removed if considered dangerous. Provided with adjustable belt.

Composition: 92% polyester, 8% spandex, with dual function treatment: quick-drying water and expulsion of perspiration through the "3M SCOTCHGARD® Treatment" fabric.

g/m²: 115

Sizes: S-M-L-XL-XXL-3XL-4XL-5XL

Colour: 049 avio blue, 081 anthracite.



Full box: 10 pcs.



9032D

Sizes: S/1 - M/2 - L/3 - XL/3 - XXL/2 - 3XL/1 = 12 pcs.



BELT INCLUDED
115 g/m²

9036B
BOOM SOFTSHELL LIGHT SHORT TROUSERS

CE CAT. I - EN ISO 13688:2013

Summer bermuda shorts in lightweight Stretch softshell 4-WAY fabric, equipped with a mobile phone pocket, ruler pocket, two rear pockets and a side pocket. Two side inserts in stretch fabric increase comfort at the waist, while the high visibility inserts offer a minimum of visibility at night. Provided with adjustable belt.

Composition: 92% polyester, 8% spandex, with dual function treatment: quick-drying water and expulsion of perspiration through the "3M SCOTCHGARD® Treatment" fabric.

g/m²: 115

Sizes: S-M-L-XL-XXL-3XL-4XL-5XL

Colour: 049 avio blue, 081 anthracite.



Full box: 10 pcs.



9036D

Sizes: S/1 - M/2 - L/3 - XL/3 - XXL/2 - 3XL/1 = 12 pcs.



8810B
BOOM
page 68



8815B
BOOM
page 68



04508B
KIND
page 7

STRETCH

Stretch line: Our Stretch line is the perfect choice for people who need flexibility and freedom of movement during work activities. These elasticated garments are designed to fit the body, allowing a full range of movement without restrictions.

Key features:

- High quality stretch fabric.
- Reinforcements in stressed areas.
- Suitable for active and dynamic professionals.

8745B

8730B

46205

ISSALINE
BY PIP

STRETCH WORKWEAR



8735 STRETCH BIB TROUSERS

CE CAT. I - EN ISO 13688:2013

With waistband, large side pocket and large rule pocket, large bib pocket for mobile provided with a shielding system against mobile's electromagnetic waves, knee-pad in reinforced and waterproof fabric, elastic adjustable barces.

Composition: 97% cotton, 3% spandex
g/m²: 260**Sizes:** S-M-L-XL-XXL-3XL**Colour:** 080 grey inserts black**Full box:** 10 pcs.

8770 STRETCH OVERALL

CE CAT. I - EN ISO 13688:2013

With elastic on waist, breathable mesh on sides. It is provided with large chest pocket for mobile with a shielding system against mobile's electromagnetic waves and several pokets of different sizes. Knee-band in reinforced waterproof fabric.

Composition: 97% cotton, 3% spandex
g/m²: 260**Sizes:** S-M-L-XL-XXL-3XL**Colour:** 080 grey inserts black**Full box:** 5 pcs.

8746B STRETCH VEST

CE CAT. I - EN ISO 13688:2013

Multipoket vest with inner mesh. It is provided with a shielding system against mobile's electromagnetic waves.

Composition: 97% cotton, 3% spandex
g/m²: 260**Sizes:** S-M-L-XL-XXL-3XL**Colour:** 080 grey inserts black**Full box:** 12 pcs.

display

8746D

Sizes: S/1 - M/2 - L/3 - XL/3 - XXL/2 - 3XL/1
= 12 pcs.

8745B STRETCH JACKET

CE CAT. I - EN ISO 13688:2013

With adjustable waist, breathable mesh on the sides. Pocket for mobile with a shielding system against mobile's electromagnetic waves, several pockets of different sizes.

Composition: 97% cotton, 3% spandex
g/m²: 260**Sizes:** S-M-L-XL-XXL-XXXL-4XL-5XL**Colour:** 080 grey inserts black**Full box:** 12 pcs.



TECHICAL AND ELASTIC STRETCH CLOTHING.



NEW
color blue

ORIGINAL

8730B STRETCH TROUSERS

CE CAT. I - EN ISO 13688:2013

Elasticated waist, large side pocket and ruler pocket, knee pad holder in reinforced and waterproof fabric.

Composition: 97% cotton, 3% spandex
g/m²: 260

Sizes: XS-S-M-L-XL-XXL-XXXL-4XL-5XL for colours 040 and 080, S-M-L-XL-XXL-XXXL for colours 025 and 050

Colour:
025 beige inserts black,
040 blue with black inserts,
050 white inserts grey,
080 grey inserts black.



Full box: 12 pcs.



8730D

Sizes:
S/1 - M/2 - L/3 - XL/3 - XXL/2 - 3XL/1 = 12 pcs.



8731B STRETCH TROUSERS

CE CAT. I - EN ISO 13688:2013

Elastic on waist, with large side pocket and ruler pocket. Knee-band in stretch fabric.

Composition: 97% cotton, 3% spandex
g/m²: 260

Sizes: S-M-L-XL-XXL-3XL

Colour:
025 beige inserts black,
040 blue inserts grey,
060 black inserts black, **only on request**
080 grey inserts black.



Full box: 12 pcs.



8731D

Sizes: S/1 - M/2 - L/3
- XL/3 - XXL/2 - 3XL/1 = 12 pcs.



NEW
4 seasons



9060B
WISE TROUSERS

CE CAT. 1 - EN ISO 13688:2013

"Wise" Stretch pant, made from 4-way stretch softshell fabric, is the ideal choice for those looking for a versatile and technical garment. In addition to the two front and back pockets, it features a large pocket on the left side and one on the right side with an additional pocket equipped with a taped zipper. Additional tool pockets, easily removable, complete the practicality of this garment. Reflective fabric inserts, although not meeting the minimum requirements for high visibility, increase visibility in low-light conditions. The elasticized waistband and removable waistband further enhance the comfort and adaptability features of this new 4 Way Stretch pant.

Plus: Zippers in the bottom of the pants, Knee pad holders, Removable pockets, Raised back waist and reinforced for added comfort, Triple stitching.

Outer composition: 92% polyester, 8% spandex

Lining composition: 100% nylon oxford

g/m²: 210

Sizes: S-M-L-XL-XXL-3XL-4XL-5XL

Colour: 083 grigio antracite/nero



box

Full box: 10 pcs.



display

9060D

S/1 - M/2 - L/3 - XL/3 - XXL/2 - 3XL/1 = 12 pcs.



Equipped with two pockets for tools (right and left) easily applicable with zipper



Raised and reinforced back waist for added comfort.

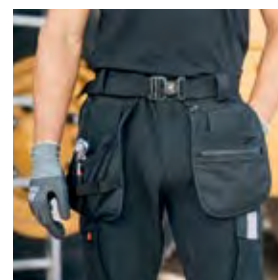

04527B POSH

page 7



04532B KEEN

page 14



04531B WISE

page 14



04533B LUCKY

page 20



MADE FROM RECYCLED PLASTIC BOTTLES



YOUR WORK MATTERS



EN 14058:2018



**FLANNEL
LINING**

**8730WB
WINTER STRETCH TROUSERS**

CE CAT. I - EN ISO 13688:2013
EN 14058:2018

Winter stretch trousers lined with inner soft flannel. Elastic waistband, side pocket and rule holder pocket, knee pad reinforced and waterproof insert fabric.

Composition outer part: 97% cotton, 3% spandex

g/m²: 260

Lining composition: flannela 60% cotton, 40% polyester

g/m²: 160

Sizes: S-M-L-XL-XXL-3XL

Colour: 080 grey with black inner pockets



Full box: 12 pcs.



8730WD

Sizes: S/1 - M/2 - L/3 - XL/3 - XXL/2 - 3XL/1 = 12 pcs.



EN 14058:2018



**FLANNEL
LINING**

**8731WB
WINTER STRETCH TROUSERS**

CE CAT. I - EN ISO 13688:2013
EN 14058:2018

Winter stretch trousers lined with inner soft flannel. Elastic waistband, side pocket and rule holder pocket, knee pad stretch insert fabric.

Composition outer part: 97% cotton, 3% spandex

g/m²: 260

Lining composition: flannela 60% cotton, 40% polyester

g/m²: 160

Sizes: S-M-L-XL-XXL-3XL

Colour: 080 grey with black inner pockets



Full box: 12 pcs.



8731WD

Sizes: S/1 - M/2 - L/3 - XL/3 - XXL/2 - 3XL/1 = 12 pcs.



**8734B
STRETCH SHORT TROUSERS**

CE CAT. I - EN ISO 13688:2013

With elastic on waist, large side pocket and rule pocket.

Composition: 97% cotton, 3% spandex

g/m²: 220

Sizes: S-M-L-XL-XXL-3XL

Colour: 025 beige inserts black, 040 blue with grey inserts, 050 white inserts grey, 080 grey inserts black



Full box: 12 pcs.



8734D

Sizes: S/1 - M/2 - L/3 - XL/3 - XXL/2 - 3XL/1 = 12 pcs.



**8772
T-SHIRT STRETCH**

CE CAT. I - EN ISO 13688:2013

Great comfort thanks to the breathability typical of cotton and the elasticity of the fabric. Perfect for work and leisure time. The color makes it perfectly matched with the trousers of the ISSALINE STRETCH line and not only.

Composition: 95% cotton, 5% elasthan

g/m²: 180

Sizes: S-M-L-XL-XXL-3XL

Colour: 040 blue inserts grey, 080 grey inserts black



Single packed in a poly bag for hanging

Full box: 20 pcs.



**8774
POLO STRETCH**

CE CAT. I - EN ISO 13688:2013

Great comfort thanks to the breathability typical of cotton and the elasticity of the fabric. Perfect for work and leisure time. The color makes it perfectly matched with the trousers of the ISSALINE STRETCH line and not only.

Composition: 95% cotton, 5% elasthan

g/m²: 180

Sizes: S-M-L-XL-XXL-3XL

Colour: 040 blue inserts grey, 080 grey inserts black



Single packed in a poly bag for hanging

Full box: 20 pcs.



**8776
LONG SLEEVES POLO STRETCH**

CE CAT. I - EN ISO 13688:2013

Great comfort thanks to the breathability typical of cotton and the elasticity of the fabric. Perfect for work and leisure time. The color makes it perfectly matched with the trousers of the ISSALINE STRETCH line and not only.

Composition: 95% cotton, 5% elasthan

g/m²: 180

Sizes: S-M-L-XL-XXL-3XL

Colour: 040 blue inserts grey, 080 grey inserts black



Single packed in a poly bag for hanging

Full box: 20 pcs.



**08196
CAMOGLI**
page 67





STRETCH EXTREME

The Stretch Extreme line is our proposal for people who deal with extreme situations and need highly resistant and flexible clothing. These garments are designed to challenge the toughest conditions without compromises.

Key features:

- Extremely technical stretch fabric.
- Reinforced seams and protective details.
- Slim fit and extremely comfortable.

8883B

8845B

8830B

8830B

46200

44400

EXTREME winter



8880B
page 10



8881B
page 25



8884B
page 11



8882B
page 18



8833B
page 63



8832B
page 63

ISSALINE
BY PIP

8845B JACKET ISSA STRETCH EXTREME

CE CAT. I - EN ISO 13688:2013

Technical jacket with anti-abrasion and reflective piping inserts, large pockets and waist adjustment ensure comfort and ease of use. Once the sleeves are removed, the garment becomes a practical vest that can be used even during the hottest months. Supplied in single hangable box.

Composition: 65% polyester, 32% cotton, 3% spandex
g/m²: 260

Sizes: 080 and 078 colour sizes: S-M-L-XL-XXL-XXXL-4XL-5XL
Other colours sizes: S-M-L-XL-XXL-XXXL

Colour:
040 blue with black inserts,
078 light grey with black inserts,
080 anthracite grey with black inserts,
200 mud with black inserts,



Full box: 10 pcs.



display

8845D

Sizes: S/1 - M/2 - L/3 - XL/3 - XXL/2 - 3XL/1 = 12 pcs.

DETACHABLE SLEEVES



8835B STRETCH EXTREME BIB

CE CAT. I - EN ISO 13688:2013

Technical bib in stretch fabric, with anti-abrasion and reflective piping inserts, possibility of length adjustment thanks to adjustable elastic straps, elastic waist and fit. Ten pockets including a mobile phone holder and a rule holder, front pocket on the bib with pen holder. Triple stitching and tenacious fabric guarantee excellent resistance. In hanging box.

Composition: 65% polyester, 32% cotton, 3% spandex
g/m²: 265

Sizes: S-M-L-XL-XXL-3XL-4XL-5XL

Colour: 080 grey anthracite with black inserts.



Full box: 10 pcs.





STRETCH EXTREME



SLIM FIT

8830B STRETCH TROUSERS EXTREME

CE CAT. I - EN ISO 13688:2013

Technical trousers with anti-abrasion and reflective piping inserts, length and width adjustment, fit and stretch fabric at the same time allow comfort and look in line with the finest technical trousers in the sports world. There are 9 pockets including a mobile phone holder and a rule holder. Triple stitching and particularly tenacious fabric guarantee excellent resistance even during toughest jobs. Supplied in single hangable box.

Composition: 65% polyester, 32% cotton, 3% spandex
g/m²: 260

Sizes: S-M-L-XL-XXL-3XL-4XL-5XL

Colour:

- 040 blue with black inserts,
- 049 avio blue with black inserts,
- 078 light grey with black inserts,
- 080 anthracite grey with black inserts,
- 200 mud with black inserts,



Full box: 10 pcs.



8830D

Sizes: S/1 - M/2 - L/3 - XL/3 - XXL/2 - 3XL/1 = 12 pcs.



8834B SHORT TROUSERS STRETCH EXTREME

CE CAT. I - EN ISO 13688:2013

Technical shorts with anti-abrasion inserts, reflective piping and stretch fabric; this garment allows both comfort and look in line with technical pants of the sports world. There are 9 pockets, including a mobile phone holder and a rule holder. Triple stitching and particularly tenacious fabric guarantee excellent resistance even during the hardest work. Supplied in single hanging box.

Composition: 65% polyester, 32% cotton, 3% spandex
g/m²: 260

Sizes: S-M-L-XL-XXL-3XL

Colour:

- 040 blue with black inserts,
- 049 avio blue with black inserts,
- 078 light grey with black inserts,
- 080 anthracite grey with black inserts,
- 200 mud with black inserts.



Full box: 10 pcs.



8834D

Sizes: S/1 - M/2 - L/3 - XL/3 - XXL/2 - 3XL/1 = 12 pcs.

SLIM FIT



ISSALINE
by PIP**BELT INCLUDED**
115 g/m²**4 WAY
STRETCH****8837B
EXTREME LIGHT TROUSERS****CE CAT. I - EN ISO 13688:2013**

Summer trousers in ultra-lightweight softshell fabric with contrasting very strong fabric. It is provided with 6 pockets, plus a mobile phone pocket and a tape measure pocket. Back reinforcement to increase resistance. Cooldry treatment. Supplied with adjustable belt and packed in box.

Composition: softshell 92% polyester, 8% spandex, with dual function treatment: rapid water drying and perspiration expulsion through the "3M SCOTCHGARD® Treatment" fabric - contrasting very strong fabric inserts.

g/m²: 115**g/m² Inserts:** 165**Sizes:** S-M-L-XL-XXL-3XL-4XL-5XL**Colour:** 049 avio blue with black inserts, 080 grey black inserts**Full box:** 10 pcs.**BELT INCLUDED**
115 g/m²**4 WAY
STRETCH****8836B
EXTREME LIGHT SHORT
TROUSERS****CE CAT. I - EN ISO 13688:2013**

shorts trousers in ultra-lightweight softshell fabric with contrasting very strong fabric. It is provided with 6 pockets a rule pocket, plus a mobile phone pocket. Back reinforcement to increase resistance. Cooldry treatment. Supplied with adjustable belt and packed in box.

Composition: softshell 92% polyester, 8% spandex, with dual-function treatment: fast rapid drying of water and expulsion of sweat thanks to the 3M SCOTCHGARD® Treatment fabric with highly resistant fabric inserts.

g/m²: 115**g/m² Inserts:** 165**Sizes:** S-M-L-XL-XXL-3XL**Colour:**049 avio blue with black inserts,
080 grey black inserts**Full box:** 10 pcs.**TPU
MEMBRANE****4 WAY
STRETCH****8832B PANTALONE
SOFTSHELL LIGHT EXTREME****CE CAT. I - EN ISO 13688:2013**

Softshell trousers with membrane ideal for work use but also suitable for sports use. The two front pockets, the mobile phone pocket and the two rear pockets are all taped for use even in extreme weather situations. Cordura fabric inserts provide high resistance at the points of greatest wear. Elasticated waist and removable belt complete the features of this new Extreme garment.

Composition outer part: 94% polyester, 6% spandex bonded microfleece

g/m² exterior: 260, contrasting fabric 300**TPU Membrane:** W/P 8.000 mm e MVP 3.000**g/m²/24 h.****Padding:** no**Sizes:** S-M-L-XL-XXL-3XL-4XL-5XL**Colour:**040 blue with black inserts and grey retroreflective inserts,
080 anthracite grey with black inserts and grey retroreflective inserts.**Full box:** 10 pcs.**8832D**

M/2 - L/2 - XL/2 - 2XL/2 = 8 pcs.

SOFTSHELL WINTER
260 g/m²**TPU
MEMBRANE****4 WAY
STRETCH****8833B HEAVY EXTREME
SOFTSHELL TROUSERS****CE CAT. I - EN ISO 13688:2013**

Long-lasting softshell trousers with membrane and microfleece, ideal for those who want a technical trouser and have to use it in particularly cold weather. Trousers equipped with four front pockets, two back pockets, a document pocket and a mobile phone pocket. Softshell fabric and Cordura inserts at the points of greatest wear guarantee excellent resistance. Elastic waistband and removable belt complete the outfit.

Composition outer part: 94% polyester, 6% spandex bonded microfleece

g/m² exterior: 320**TPU Membrane:** W/P 8.000 mm e MVP 3.000**g/m²/24 h.****Padding:** no**Sizes:** S-M-L-XL-XXL-3XL-4XL-5XL**Colour:**

060 black with light grey retroreflective inserts,

**Full box:** 10 pcs.**8833D**

M/2 - L/2 - XL/2 - 2XL/2 = 8 pcs.

SOFTSHELL WINTER
320 g/m²



EXTREME



EXTREME SUMMER



**8825NB
POLO STRETCH
EXTREME**
page 69



**8820NB
T-SHIRT STRETCH
EXTREME**
page 69

EXTREME WINTER



**8880B SILKY
EXTREME**
page 10



**8881B REVENGE
EXTREME**
page 25



**8884B CLEVER
EXTREME**
page 11



**8882B CUNNY
EXTREME**
page 18



**8883B TUBE
EXTREME**
page 27



**8833B
HEAVY
EXTREME**
page 63



**8832B
LIGHT
EXTREME**
page 63

EXTREME SHOES



44220 EXTREME
page 202



**46200 EXTREME
STRETCH**
page 203



**46205 EXTREME
STRETCH**
page 203



**44400 EXTREME
STRETCH**
page 202



46300 EXTREME
page 203



46305 EXTREME
page 203

ISSALINE
BY PIP

T-SHIRT e POLO

08189

16-541-EN



8180
T-SHIRT SORRENTO

With sweatband in the neck.

Composition: 100% cotton

g/m²: 160

Sizes: M-L-XL-XXL

Colour:

030 orange,
040 blue,
050 white,
060 black,
080 grey.

Single packed in a poly bag

Full box: 30 pcs.



08185
POLO CAPRI

Combed cotton, with sweatband in the neck.

Composition: 100% cotton

g/m²: 200

Sizes: M-L-XL-XXL

Colour:

030 orange,
040 blue,
050 white,
060 black, **only on request**
080 grey.

Single packed in a poly bag

Full box: 20 pcs.



08189L
POLO PORTOFINO LADY

Made of stretch cotton, absorbs sweat. Women's conformed.

Composition: 95% cotton, 5% elasthan.

g/m²: 190

Sizes: S-M-L-XL-XXL

Colour:

040 blue,
050 white,
080 grey.

Single packed in a poly bag for hanging

Full box: 20 pcs.





08182
T-SHIRT RAPALLO

T-shirt in combed cotton jersey with piping contrasting sleeves and neck, breathable finishes neckline with "V" seam.

Composition: 100% cotton

g/m²: 160

Sizes: S-M-L-XL-XXL-3XL

Colour:

023 bottle green,
024 military green,
040 blue,
050 white,
060 black,
070 red,
080 grey.

Single packed in a poly bag

Full box: 20 pcs.



08189
POLO STRETCH PORTOFINO

Stretch cotton polo shirt with contrasting piping on sleeves and on the edge of the collar with sweatband on the neck.

Composition: 95% cotton, 5% elastan.

g/m²: 190

Sizes: S-M-L-XL-XXL-3XL

Colour:

024 military green,
040 blue,
060 black,
070 red,
080 grey.

Single packed in a poly bag for hanging

Full box: 20 pcs.

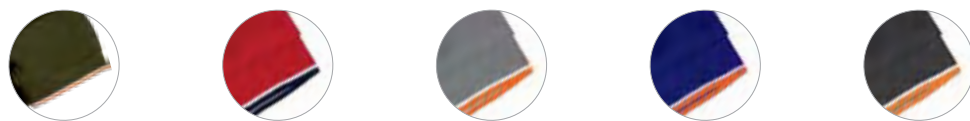

08196
POLO STRETCH CAMOGLI

CE CAT. I - EN ISO 13688:2013

Stretch cotton long sleeves polo shirt with contrasting piping on sleeves and on the edge of the collar with sweatband on the neck.

Composition: 95% cotton, 5% elastan piquet.

g/m²: 190

Sizes: S-M-L-XL-XXL-3XL

Colour:

040 blue,
060 black,
080 grey.

Single packed in a poly bag

Full box: 20 pcs.

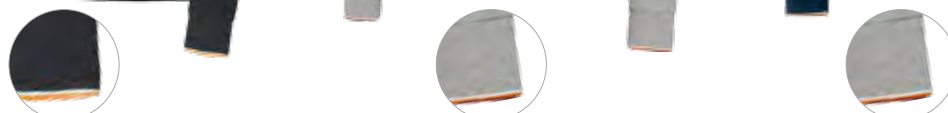



POLO and T-SHIRT in stretch fabric



8772 T-SHIRT STRETCH

CE CAT. I - EN ISO 13688:2013

Great comfort thanks to the breathability typical of cotton and the elasticity of the fabric. Perfect for work and leisure time. The color makes it perfectly matched with the trousers of the ISSALINE STRETCH line and not only.

Composition: 95% cotton, 5% elasthan

g/m²: 180

Sizes: S-M-L-XL-XXL-3XL

Colour:

040 blue inserts grey

080 grey inserts black

Single packed in a poly bag for hanging

Full box: 20 pcs.



8774 POLO STRETCH

CE CAT. I - EN ISO 13688:2013

Great comfort thanks to the breathability typical of cotton and the elasticity of the fabric. Perfect for work and leisure time. The color makes it perfectly matched with the trousers of the ISSALINE STRETCH and not only.

Composition: 95% cotton, 5% elasthan

g/m²: 180

Sizes: S-M-L-XL-XXL-3XL

Colour:

040 blue inserts grey

080 grey inserts black

Single packed in a poly bag for hanging

Full box: 20 pcs.



8776 LONG SLEEVES POLO STRETCH

CE CAT. I - EN ISO 13688:2013

Long sleeves polo in stretch fabric with great comfort thanks to the breathability typical of cotton and the elasticity of the fabric. Perfect for work and leisure time. The color makes it perfectly matched with the trousers of the ISSALINE STRETCH and not only.

Composition: 95% cotton, 5% elasthan

g/m²: 180

Sizes: S-M-L-XL-XXL-3XL

Colour:

040 blue inserts grey

080 grey inserts black

Single packed in a poly bag for hanging

Full box: 20 pcs.



8810B T-SHIRT BOOM

CE CAT. I - EN ISO 13688:2013

"Boom" line T-shirt in stretch cotton with front pocket.

Composition: 100% cotton jersey

g/m²: 160

Sizes: S-M-L-XL-XXL-3XL

Colour: 040 air force blue with black inserts, 080 anthracite with black inserts.

box

Full box: 20 pcs.



8815B POLO BOOM

CE CAT. I - EN ISO 13688:2013

Stretch cotton "Boom" polo shirt with front pocket.

Composition: 95% cotton piquet, 5% elasthan

g/m²: 180

Sizes: S-M-L-XL-XXL-3XL

Colour: 040 air force blue with black inserts, 080 anthracite with black inserts.

box

Full box: 20 pcs.

ISSALINE
by PIP**8820NB
EXTREME STRETCH COTTON T-SHIRT****CE CAT. I - EN ISO 13688:2013**

Extreme T-shirt in stretch cotton, with front pocket and abrasion resistant inserts on the shoulders (covered inside to avoid abrasion on the skin).

Composition: 100% stretch cotton (mechanical)**g/m²:** 160**Sizes:** S-M-L-XL-XXL-3XL**Colour:** 040 blue with black inserts, 078 grey inserts black**Full box:** 20 pcs.**8825NB
POLO STRETCH EXTREME****CE CAT. I - EN ISO 13688:2013**

Extreme polo shirt in stretch cotton, with front pocket and abrasion resistant inserts on the shoulders (covered inside to avoid abrasion on the skin).

Composition: 95% cotton, 5% elastan**g/m²:** 190**Sizes:** S-M-L-XL-XXL-3XL**Colour:** 040 blue with black inserts, 078 grey inserts black**Full box:** 20 pcs.**08160
LONG SLEEVES SHIRT****CE CAT. I - EN ISO 13688:2013**

Fastening with buttons, little chest pockets with pen pocket. Button on cuffs.

Composition: 100% oxford cotton**g/m²:** 250**Sizes:** S-M-L-XL-XXL**Colour:** 110 light blue.**Full box:** 12 pcs.



The world is built by workers

We are the skin of the builders, repairers, maintainers and fabricators.

Because your work is important and our goal is to offer you a safe and comfortable way to do it, always preserving style.

A brand with decades of experience in the world of workwear and PPE, with an essence and origin from Italian style.

Because it's not just about what you do, but how you do it.



250-89-0008-EN

AK9050N

8820NB

16-854-EN

8025BP

46205



Issa socks are designed thinking of use that can makes a worker wearing them with safety shoes or athlete engaged in race or training. Mixing natural fibers (cotton and wool) with technical fibers (Kevlar, Coolmax, nylon, elastam, etc.) can get an excellent result in terms of strenght and footwellness. Issa socks are ready to face all challenges, you will always find the most suitable sock for your needs.



ESPOSOCKS

Empty counter display

WINTER

**01CHOCL
HOCKEY**

Prized merino wool allows the maintenance of body heat and the avoidance of the accumulation of moisture, even in the harshest temperatures. The sock is industrially pre-washed and is naturally anti-bacterial. The anatomical reinforcements, the high-density insole, and the anti-stress cuffs guarantee pleasant comfort.

Composition: 90% Merino wool, 10% polyamide

Sizes: S (35-38 conformed woman), M (39-42), L (43-46), XL (47-50)

Colour / lenght: 019 ecru / long

in blister

Minimum order: 3 pairs per size

Full box: 24 pairs.



WINTER

**01CCARL
CARVING**

Technical sock that provides excellent protection to those who work in particularly cold environments by mixing different materials. The anti-torsion elastic band, the reinforcements, and the impact-cushioning insole make the article ideal also for use in sports.

Composition: 35% wool, 30% Acrylic, 20% Cotton, 15% Polyamide

Sizes: S (35-38 conformed woman), M (39-42), L (43-46), XL (47-50)

Colour / lenght: 80 grey / long

in blister

Minimum order: 3 pairs per size

Full box: 24 pairs.



WINTER

**01CBIAL
BIATHLON**

The article has a decidedly sporty fit thanks to its anatomical structure and the tubular and elastic inserts distributed on the foot, ankle, and leg. The breathable and heat-regulating Tactel Multisoft fleece fabric guarantees an ideal and constant microclimate even in the coldest weather.

Composition: 100% anti-bacterial Tactel.

Sizes: S (35-38 conformed woman), M (39-42), L (43-46), XL (47-50)

Colour / lenght: 060 black inserts grey / long

in blister

Minimum order: 3 pairs per size

Full box: 24 pairs.



**ALL SEASONS
REINFORCEMENT KEVLAR®**

**00680
KEVLO**

This socks has 3 important characteristics: antibacterial Amicor Plus that prevents bad odors, Kevlar that keeps the most stressed points (toe and heel) more resistant and the particular anatomic shape (there is a right sock and a left one). The average weight let the worker wear it throughout all the year.

Composition: 50% cotton, 30% polyamide, 10% elastomer, 8% aramid, 2% elasthan

Sizes: S (35-38 conformed woman), M (39-42), L (43-46), XL (47-50)

Colour / lenght: 060 black inserts red, grey, yellow Kevlar / long

in blister

Minimum order: 3 pairs per size

Full box: 24 pairs.



**ALL SEASONS
REINFORCEMENT KEVLAR®**

**01CTRIC
TRIATHLON**

This sock has got three important charatteristics: Amicor Plus anti-bacterial that reduce the bad smell, Kevlar that give more resistance to the abrasion on the most stressed point (toe and heel) the special anatomic form (exist a left sock and a right one). The medium weight allows a all seasons use.

Composition: 50% cotton, 15% Amicor Plus, 15% polyamide, 10% elastomer, 8% Kevlar, 2% elasthan

Sizes: S (35-38 conformed woman), M (39-42), L (43-46), XL (47-50)

Colour / lenght: 060 black inserts grey, yellow Kevlar / medium

in blister

Minimum order: 3 pairs per size

Full box: 24 pairs.



**ALL SEASONS
REINFORCEMENT KEVLAR®**

**01COKVL
KV**

The use of Kevlar, a high-tenacity fiber, guarantees this innovative sock with extreme resistance on the toe and heel, the parts subjected to the greatest friction. The anatomic structure and the graduated pressure mesh allow use for both work and sports. The average weight of the sock makes it usable throughout practically the entire year, in non-extreme conditions.

Composition: 62% cotton, 25% polyamide, 8% elastan, 5% aramid

Sizes: S (35-38 conformed woman), M (39-42), L (43-46), XL (47-50)

Colour / lenght: 060 black inserts yellow Kevlar / long

in blister

Minimum order: 3 pairs per size

Full box: 24 pairs.





 **ALL SEASONS**

**00670
DUOSLALOM**

Pack of 2 pairs of winter sock SLALOM. Despite of its limited thickness, this sock can have a good resistance to cold thanks to Merinos wool. The good pressure on the calf benefit the blood circulation and give a winding-down effect.

Composition: 23% Merino wool, 25% acrylic, 29% polypropylene, 18% polyamide, 2% elastan e 1% carbon fiber.

Sizes: S/M (38-42), L/XL (43-47).

Colour / lenght: O60 one pair grey/black with green inserts and one pair grey/black with orange inserts / long

 in blister

Minimum order: 3 blister of 2 pairs

Full box: 12 blister da 2 pairs.



 **ALL SEASONS**

**01COFFL
OFFICE**

Meryl Skinlife, a technological bacteriostatic fiber, prevents the formation of bad odors. Anallergic and breathable, with heat-regulating properties. The particular elasticity, the industrial prewashing, and the aforementioned features make this sock a versatile product ideal for all seasons, except in extreme situations.

Composition: 100% Meryl Skinlife

Sizes: S (35-38 conformed woman), M (39-42), L (43-46), XL (47-50)

Colour / lenght: O60 black / long

 in blister

Minimum order: 3 pairs per size

Full box: 24 pairs.

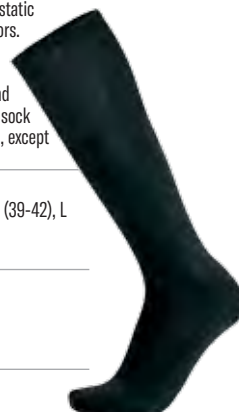

 **ALL SEASONS**

**01CBASF
BASKET**

The Dupont Coolmax fabric favors the outward expulsion of sweat, giving the foot excellent heatregulation. The average density structure, the elastic on the foot and the anatomical reinforcements provide protection from impacts and micro-traumas while at the same time carrying out a relaxing action.

Composition: 60% polyester, 25% cotton, 12% polyamide, 3% elastan

Sizes: S (35-38 conformed woman), M (39-42), L (43-46), XL (47-50)

Colour / lenght: O80 grey / average lenght (American)

 in blister

Minimum order: 3 pairs per size

Full box: 24 pairs.

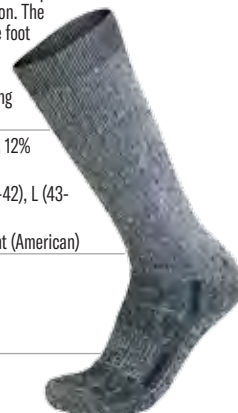

 **SUMMER**

**01CBIK
BIKER**

Sock «invisible» keeps the foot always cool and dry. The entire slab of the foot is an average density for cushion shock and give a nice touch to the foot. The back tab is slightly padded and protects the tendon from friction of the ankle. Ideal in the warmer months using safety shoes or sports shoes fabric.

Composition: 75% cotton, 22% polyamide, 3% elastan

Sizes: S (35-38 conformed woman), M (39-42), L (43-46), XL (47-50)

Colour / lenght: O60 black / equal shoes

 in blister

Minimum order: 3 pairs per size

Full box: 24 pairs.



 **SUMMER**

**01CRUNC
RUNNER**

Thanks to Coolmax sock provides excellent breathability and thermal comfort even in the hottest periods of the year. The entire sole of the foot is protected from a medium density slab for mitigating impacts. The elastic band torsion and anti-stress cuff enhances the fit and performance both at work and sport.

Composition: 70% polyester, 25% polyamide, 5% elastan

Sizes: S (35-38 conformed woman), M (39-42), L (43-46), XL (47-50)

Colour / lenght: O80 light grey - dark grey / short

 in blister

Minimum order: 3 pairs per size

Full box: 24 pairs.



 **SUMMER**

**00655
DUOBIKE**

«Invisible» sock that keeps always your foot cool and dry. The mid-density insole protects against impacts and it is very comfortable. The back tongue is a lightly padded and protects ankle's tendon against friction. It is ideal in the hottest months together with safety shoes or sports shoes.

Composition: 75% Cotton, 22 Polyamide, 3% elastomer

Sizes: M (38-42), L (43-47)

Colour / lenght: O60 black inserts yellow, orange / equal shoes

 in blister

Minimum order: 3 blisters of 2 pairs

Full box: 12 blisters (24 pairs).



 **SUMMER**

**00650
DUORUN**

Thanks to Coolmax, this sock is very breathable and allows a thermic comfort also during the hottest periods of the year. A mid-density insole protects all the sole against impacts. Anti-torsion elastic band and anti-stress cuff enhance its wearability and performances during both work and sports.

Composition: 70% polyester, 25% polyamide, 5% elastan

Sizes: M (38-42), XL (43-47)

Colour / lenght: O60 black inserts green, orange / short

 in blister

Minimum order: 2 pairs

Minimum order: 3 blisters of 2 pairs

Full box: 12 blisters (24 pairs).



**706 only on request
ECONOMIC SOCKS**

Work socks of various colors. Economic.

Composition: 40% cotton, 40% acrylic, 5% elastan, 15% other fibres.

Sizes: one size.

Colour / lenght: various/long.

Minimum order: 3 per size

Full box: 72 pairs.

**707 only on request
Cotton**

Cool and comfortable cotton socks.

Composition: 100% cotton.

Sizes: one size.

Colour / lenght: O50 white, O60 black / long.

Full box: 120 pairs.





THERMO

ALSO FOR WINTER
SPORTS ACTIVITIES



8780 ISSALINE THERMO T-SHIRT

Thermal T-shirt with inner flannel that makes this garment very comfortable thanks also to the natural elasticity of the fabric. This specificity of the fiber ensures excellent thermal resistance and facilitates the expulsion of sweat outwards keeping the skin dry.

Composition: 100% polyester
g/m²: 150
Sizes: M(S/M) - XL(L/XL) - 3XL(XXL/3XL).
Colour: 080 grey mélange with orange flat seams

box
Full box: 5 pcs.

8785 ISSALINE THERMO TROUSERS

Thermal trousers with inner flannel that makes this garment very comfortable thanks also to the natural elasticity of the fabric. This specificity of the fiber ensures excellent thermal resistance and facilitates the expulsion of sweat outwards keeping the skin dry.

Composition: 100% polyester
g/m²: 150
Sizes: M(S/M) - XL(L/XL) - 3XL(XXL/3XL).
Colour: 080 grey mélange with orange flat seamse

box
Full box: 5 pcs.



DRY STRETCH

ALSO FOR SPORTS
ACTIVITIES IN ALL
SEASONS

- ISSALINE DRY STRETCH
- Always dry on the skin
- Warm in winter
- Fresh in summer

8795 SHORT SLEEVE T-SHIRT ISSALINE DRY STRETCH

T-Shirt ISSALINE Dry Stretch fabric.
Composition: polyamide, polypropylene and elastan.
Sizes: M(S/M) - XL(L/XL) - 3XL(XXL/3XL).
Colour: 080 grey

box
Full box: 5 pcs.

8790 THREE QUARTER ISSALINE DRY STRETCH

Pants ISSALINE Dry Stretch fabric.
Composition: polyamide, polypropylene and elastan.
Sizes: M(S/M) - XL(L/XL) - 3XL(XXL/3XL).
Colour: 080 grey

box
Full box: 5 pcs.



8797 LONG SLEEVE T-SHIRT ISSALINE DRY STRETCH

Long sleeves T-shirt ISSALINE Dry Stretch fabric.
Composition: polyamide, polypropylene and elastan.
Sizes: M(S/M) - XL(L/XL) - 3XL(XXL/3XL).
Colour: 080 grey

box
Full box: 5 pcs.

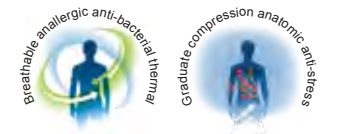



ISSALINE

BY PIP

Clothing

Hi-Vi HIGH VISIBILITY

ISSALINE by PIP offers high-visibility workwear that combines safety and comfort for working professionals. Our high-visibility line is synonymous with compliance with current regulations and ensures a safer work environment. Let's explore together the different types of garments offered by ISSALINE by PIP.

Hi-Vi jackets are carefully designed to ensure maximum visibility in low-light conditions. The tri-color design not only meets safety standards, but also offers a comfortable and durable fit, ensuring optimal performance.

Hi-Vi vests are ideal for operators who need freedom of movement. Made from high-quality, reflective fabrics, ISSALINE vests provide visibility and safety without compromising comfort.

Hi-Vi pants combine style and function, providing reliable protection with durable, reflective materials. The range of sizes and fits offers a wide selection to fit every worker.

Hi-Vi polo shirts and t-shirts for a professional look without sacrificing safety are the ideal choice. With breathable and reflective materials, they combine style and safety for workers who work on the street or construction site.

Hi-Vi suits for environments that require extra attention to safety, offering protection without compromising freedom of movement. With reflective details and a comfortable fit.

In conclusion, ISSALINE by PIP is committed to providing high-quality solutions for workplace safety.

Note: The certification values shown in this catalogue may vary due to the continuous updating process; for exact data, please ask for updated technical data sheet.



WATERPROOF AND BREATHABLE



4 IN 1 TOP OF RANGE



04631N HI-VI 4 IN 1 BICOLOUR JACKET

(04641N + 04648N)

EN ISO 13688:2013 - EN ISO 20471:2013 + A1:2016 - EN 343

Outer jacket (04641N): rollaway hood, fastener with zipper covered with flap and snap buttons, two outer tridimensional and double purpose muff pockets (one with badge holder), mobile phone pocket, drawstring waistband, 3M Scotchlite® reflective bands. Sealed seams. Lower body and sleeves in blue contrast tonality to reduce dirty's exposure.

Composition: - main fabric (yellow fluo / orange fluo): waterproof and breathable 300D polyester oxford PU coated with Teflon treatment - insert fabric (blue navy): waterproof and breathable 210D nylon oxford PU coated with Teflon treatment - body lining: 100% mesh polyester ; sleeve lining: taffeta polyester.

Inner jacket (04648N): fastener with buttons, two outer pockets, 3M Scotchlite® reflective bands. Detachable quilted and padded sleeves. Rib knit cuffs.

Composition: - main fabric (yellow fluo / orange fluo): waterproof 300D polyester oxford PU coated with Teflon treatment, polyester padding and quilted lining - sleeve fabric (blue navy): quilted 240T pongee polyester with padding and lining polyester

Sizes: S-M-L-XL-XXL-3XL

Colour: 012 yellow fluo /blue, 032 orange fluo /blue

Full box: 5 pcs.

4 IN 1 TOP OF RANGE



04630N HI-VI 4 IN 1 BICOLOUR JACKET

(04643N + 04648N)

EN ISO 13688:2013 - EN ISO 20471:2013 + A1:2016 - EN 343

NB: IT CAN BE ORDERED WITHOUT INNER JACKET = 04643N

Giacca esterna (04643N): Outer jacket (04643N): rollaway hood, fastener with zipper covered with flap and snap buttons, two outer tridimensional and double purpose muff pockets (one with badge holder), mobile phone pocket, drawstring waistband, 3M Scotchlite® reflective bands. Sealed seams.

Composition: - waterproof and breathable 300D polyester oxford PU coated with Teflon treatment - body lining: 100% mesh polyester ; sleeve lining: taffeta polyester.

Inner jacket (04648N): fastener with buttons, two outer pockets, 3M Scotchlite® reflective bands. Detachable quilted and padded sleeves. Rib knit cuffs.

Composition: - main fabric (yellow fluo / orange fluo): waterproof 300D polyester oxford PU coated with Teflon treatment, polyester padding and quilted lining - sleeve fabric (blue navy): quilted 240T pongee polyester with padding and lining polyester

Sizes: S-M-L-XL-XXL-3XL

Colour: 012 yellow fluo, 032 orange fluo

Full box: 5 pcs.



Detachable
04648N

DETACHABLE SLEEVES



04648N HI-VI PADDED BODYWARMER

(interno del 04630N e del 04631N)

EN ISO 13688:2013 - EN ISO 20471:2013 + A1:2016

Fastener with snap buttons, two outer pockets, 3M Scotchlite® reflective bands. Detachable quilted and padded sleeves. Rib knit cuffs.

Composition: - main fabric (yellow fluo / orange fluo): waterproof 300D polyester oxford PU coated with Teflon treatment, polyester padding and quilted lining - sleeve fabric (blue navy): quilted 240T pongee polyester with padding and lining polyester

Sizes: S-M-L-XL-XXL-3XL

Colour: 012 yellow fluo, 032 orange fluo

Full box: 10 pcs.

N.B: it is the inner bodywarmer of 04630N and 04631N



04643N + 04648 = 04630N



4 IN 1



04638N VALDIEZZA - HI-VI 4 IN 1 BICOLOUR JACKET

(04639 + 04649)

EN ISO 13688:2013 - EN ISO 20471:2013 + A1:2016 - EN 343

Outer jacket (04639): rollaway hood, fastener with flap and snap buttons, two outer pockets (one with badge holder), mobile phone pocket, drawstring waistband, reflective bands. Sealed seams. Lower body and sleeves in blue contrast tonality to reduce dirty's exposure. Unlined.

Composition: - main fabric (yellow fluo / orange fluo): waterproof 300D polyester oxford PU coated - insert fabric (blue navy): waterproof 210D nylon oxford PU coated.

Inner jacket (04649): fastener with buttons, two outer pockets, reflective bands. Detachable quilted and padded sleeves. Rib knit cuffs.

Composition: - main fabric (yellow fluo / orange fluo): waterproof 300D polyester oxford PU coated, polyester padding and quilted lining - sleeve fabric (blue navy): quilted polyester with padding and lining polyester

g/m²: 130

g/m² polyester padding: 180

Sizes: S-M-L-XL-XXL-3XL + colour 047 4XL-5XL

Colour: 047 orange fluo / blue, 048 yellow fluo/blue,

Full box: 5 pcs.

4 IN 1



ANTI-COLD OF SERVICE (Category I)
To be used where it is not required the use of clothing specifically certified.

04610 PARKA FOUR SEASONS

CE CAT. I - EN ISO 13688:2013

4 IN 1 waterproof winter jacket with reflective bands.

OUTER: waterproof with four pockets, rollaway hood, drawstring waistband, badge holder.

INNER (DETACHABLE): anti cold that can be worn alone with reflective bands, two outer pockets plus inner pocket, drawstring waistband.

Composition: polyester

Sizes: S-M-L-XL-XXL

Colour: 041 ink blue

Full box: 10 pcs.

REVERSIBLE DETACHABLE SLEEVES



04715 REVERSIBLE HI-VI PILOT

EN ISO 13688:2013 - EN ISO 20471:2013 + A1:2016

Reversible pilot jacket that serves a dual purpose as workwear high visibility one side, while the other side looks like a pleasant non-reflecting blue pilot for leisure activities. Fastener with zipper, detachable sleeves, knitted cuffs and waistband, four outer pockets and four zipped inner ones. Sleeve zipped pocket. Reflective bands.

Composition: polyester / cotton

Sizes: S-M-L-XL-XXL

Colour: 032 orange fluo / blue

Full box: 10 pcs.



Detachable



TPU
MEMBRANE

**04512
FLASH**

EN ISO 13688:2013 EN ISO 20471:2013 + A1:2016

Hi Vi certified softshell jacket ; with all benefits (lightness, breathability, waterproofing, windproofing, good cold-resistance) for those ones who requires to be visible. With three outer and three inner pockets (of which one mobile phone pocket). Provided with practical roller key holder.

Composition: 100% polyester, softshell (polyester/spandex) with TPU

Membrane TPU: W/P 10.000 mm e MVP 3.000 g/m²/24 h.

Sizes: S-M-L-XL-XXL-3XL

Colour:

012 yellow fluo /navy blue,

032 orange fluo /navy blue.

Full box: 10 pcs.

SOFTSHELL



REVERSIBLE

**04069
REVERSE**

EN ISO 13688:2013 - EN ISO 20471:2013 + A1:2016

Practical "travel companion" for all those who may be walking or working outdoor: wearing it in one side makes visible, wearing it on the other provides sober and sporty appearance. Reversible with four patch pockets on blue side and one mobile phone pocket on HI-VI side.

Composition: 100% polyester

Sizes: S-M-L-XL- XXL-3XL

Colour:

047 blue/orange fluo,

048 blue/yellow fluo

Full box: 20 pcs.



FLEECE

**04053
HI-VI BICOLOUR
PULLOVER**

EN ISO 13688:2013 - EN ISO 20471:2013 + A1:2016

HI-VI fleece pullover, turtleneck zipper closure, elastic cuffs and waistband. Zipped pocket and two pockets. Anti pilling treatment. 3M Scotchlite® reflective bands.

Composition: 100% polyester

Sizes: S-M-L-XL- XXL

Colour: 032 orange fluo/blue

Full box: 10 pcs.



SWEAT SHIRT

**04827
MIRROR**

EN ISO 13688:2013 - EN ISO 20471:2013 + A1:2016

HI-VI bicolour sweatshirt with central full zipper, two front pockets and two large inner pockets. Blue inserts, in addition to improving their aesthetics, protect the garment where it tends to get dirty the most.

Composition: 25% cotton fleece, 75% polyester

g/m²: 280

Sizes: S-M-L-XL- XXL-3XL

Colour: 047 orange fluo/blue.

Full box: 10 pcs.



WATERPROOF

**01800
GLARE HI-VI RAINSET**

EN ISO 13688:2013 - EN ISO 20471:2013 + A1:2016

Waterproof rainset jacket and trousers certified high visibility, delivered in hangable packets. Taped seams, trousers with two pockets, elastic waistband and two regulating buttons on the lower part; jacket with small hood, two front pockets and zip flap.

Composition: 150D polyester oxford/PU

Sizes: S-M-L-XL- XXL-3XL

Colour:

047 orange fluo/blue

048 yellow fluo/blue

Single packed in a poly bag for hanging

Full box: 20 set.



ISSALINE
BY PIPEN ISO
20471:2013-A1:2016
EN ISO 13688:2013**8445
HI-VI JACKET**EN ISO 13688:2013 - EN ISO
20471:2013 + A1:2016

Two patch pockets with flap and button closure. Fastener with flap covered buttons and cuffs with buttons, adjustable waist with buttons. Shirt collar. Reflective bands on chest and sleeves.

Composition: 60% cotton, 40% polyester

g/m²: 240

Sizes: S-M-L-XL- XXL-3XL

Colour:

032 orange fluo,
047 orange fluo/blue,
048 yellow fluo/blue.

Full box: 18 pcs.



Pocket and badge holder

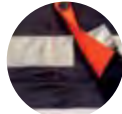

Jacket's fastening with covered buttons

EN ISO
20471:2013-A1:2016
EN ISO 13688:2013**8430N
HI-VI TROUSERS**EN ISO 13688:2013 - EN ISO
20471:2013 + A1:2016

Front slanted welt pockets, side bellow pocket with flap and velcro and badge holder, rear pocket with button, rule holder pocket. Back elastic waistband. Leg bottom reflective bands. Fly with zipper closure.

NB: size S also complies to EN 20471

Composition: 60% cotton, 40% polyester

g/m²: 240

Sizes:

032: S-M-L-XL- XXL-3XL

047-048: S-M-L-XL- XXL

Colour:

032 orange fluo,
047 orange fluo/blue,
048 yellow fluo/blue.

Full box: 18 pcs.



pocket and badge holder

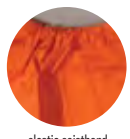

elastic waistband



rule pocket



Reflective bands 5, 6 or 7 cm

**LIGHT
185 g/m²**EN ISO
20471:2013-A1:2016
EN ISO 13688:2013**8438
HI-VI LIGHT TROUSERS**

EN ISO 13688:2013 - EN ISO 20471:2013 + A1:2016

Very light high visibility trousers, suitable in summer months, elastic waistband, side pocket, 2 front pockets, rear pocket and rule holder pocket. Flap with zip.

Composition: 65% polyester e 35 % cotton twill

g/m²: 185

Band washing: 25

Sizes: S-M-L-XL- XXL-3XL-4XL-5XL

Colour:

047 orange fluo/blue,

Full box: 20 pcs.

EN ISO
20471:2013-A1:2016
EN ISO 13688:2013**8434
HI-VI SHORT TROUSERS**EN ISO 13688:2013 - EN ISO 20471:2013
+ A1:2016

Front welt pockets with oblique opening, back pocket with flap and button. Belt loops on waist. Double reflective bands on the bottom part.

Composition: 60% cotton, 40% polyester

g/m²: 240

Sizes: S-M-L-XL- XXL

Colour:

012 yellow fluo,
032 orange fluo

Full box: 20 pcs.





EN ISO
20471:2013+A1:2016
EN ISO 13688:2013

8470 HI-VI COVERALL

EN ISO 13688:2013 - EN ISO 20471:2013 + A1:2016

Two patch pockets and two smaller ones with flap and button. Rear pocket with buttons and rule holder pocket. Back elastic waistband. Fastener with concealed nylon zipper, side pocket with velcro closure and badge holder. Shirt collar. Reflective bands on chest, sleeves and leg button.

Composition: 60% cotton, 40% polyester

g/m²: 240

Sizes: S-M-L-XL-XXL-3XL

Colour:

032 orange fluo,
047 orange fluo/blue,
048 yellow fluo/blue

Full box: 10 pcs.

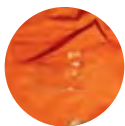

pocket and badge holder

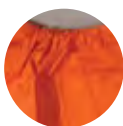

elastic waistband



rule pocket



Reflective bands 5, 6 or 7 cm



FUSTIAN



FUSTIAN



EN ISO
20471:2013+A1:2016
EN ISO 13688:2013

8547 HI-VI FUSTIAN JACKET

EN ISO 13688:2013 - EN ISO 20471:2013 + A1:2016

High-visibility fustian jacket with patch pockets and concealed badge holder. Reflective bands.

Composition: 50% brushed fustian cotton, 50% polyester

g/m²: 350

Sizes: S-M-L-XL-XXL-3XL

Colour: 032 orange fluo /blue

Full box: 10 pcs.



EN ISO
20471:2013+A1:2016
EN ISO 13688:2013

8532 HI-VI FUSTIAN TROUSERS

EN ISO 13688:2013 - EN ISO 20471:2013 + A1:2016

HI-VI fustian trousers with back pocket, rule holder pocket and two side cargo pockets. Elastic waistband and zipper closure. Concealed badge holder on left leg pocket. Reflective bands.

Composition: 50% brushed fustian cotton, 50% polyester.

g/m²: 350

Sizes: S-M-L-XL-XXL-3XL

Colour: 032 orange fluo/blue

Full box: 10 pcs.

8032
FUSTIAN
page 37





VEST HIGH VISIBILITY



01210N HI-VI VEST

EN ISO 13688:2013

EN ISO 20471:2013 + A1:2016

Fastening with velcro. Reflective bands.

Composition: 100% polyester

g/m²: 120

Band washing: 25

Sizes: one size

Colour: 012 yellow fluo, 032 orange fluo.

Single packed in a poly bag

Full box: 50 pcs.



Detail fastening with velcro



01210NB HI-VI VEST WITH BADGE HOLDER

EN ISO 13688:2013

EN ISO 20471:2013 + A1:2016

Fastening with velcro. Reflective bands. With badge holder.

Composition: 100% polyester

g/m²: 120

Band washing: 25

Sizes: one size

Colour: 012 yellow fluo, 032 orange fluo.

Single packed in a poly bag

Full box: 50 pcs.



MULTY POCKET



01250 HI-VI VEST WITH POCKETS

EN ISO 13688:2013

EN ISO 20471:2013 + A1:2016

Fastening with Velcro, 2 outer pockets and a mobile phone pocket. Stitched reflective bands. With badge holder.

Composition: 60% cotton, 40% polyester

g/m²: 240

Band washing: 25

Sizes: L (M/L) - XXL (XL/XXL)

Colour: 012 yellow fluo, 032 orange fluo.

Single packed in a poly bag

Full box: 25 pcs.



01260 HI-VI VEST ZIP

EN ISO 13688:2013

EN ISO 20471:2013 + A1:2016

Very light vest with 2 front pockets, mobile phone pocket and a practical front zip.

Composition: 100% polyester tricot

g/m²: 120

Band washing: 25

Sizes: L (M/L) - XXL (XL/XXL)

Colour: 012 yellow fluo, 032 orange fluo.

Single packed in a poly bag

Full box: 25 pcs.



01265 VEST MESH PERFORATED

EN ISO 13688:2013

EN ISO 20471:2013 + A1:2016

HV vest in perforated fabric, perfect for summer time with two large front pockets and one mobile phone pocket, front zip closure.

Composition: 100% twill mesh polyester

g/m²: 160

Band washing: 25

Sizes: L (M/L) - XXL (XL/XXL)

Colour: 012 yellow fluo, 032 orange fluo.

Single packed in a poly bag

Full box: 25 pcs.



Perforated fabric detail

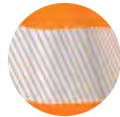

Segmented bands
heat-sealed

50% Cotton



Segmented bands
heat-sealed



EN ISO
20471:2013 + A1:2016
EN ISO 13688:2013

08194N HI-VI POLO SHIRT

EN ISO 13688:2013 - EN ISO 20471:2013 + A1:2016

Practical and light long-sleeved polo shirt certified HV with 50% cotton fabric in order to increase comfort and breathability. Heat-welded reflective bands and a chest pocket.

Composition: 50% cotton, 50% polyester

g/m²: 150

Sizes: S- M-L-XL-XXL-3XL

Colour:

047 orange fluo with blue inserts

048 yellow fluo with blue inserts.

Single packed in a poly bag

Full box: 15 pcs.



EN ISO
20471:2013 + A1:2016
EN ISO 13688:2013

08190N HV POLO SHIRT

EN ISO 13688:2013 - EN ISO 20471:2013 + A1:2016

A practical and lightweight polo shirt, certified, with 50% cotton to increase, in compliance with legal constraints, comfort and breathability. Heat-welded reflective bands.

Composition: 50% cotton piqué, 50% polyester

g/m²: 165

Band washing: 25

Sizes: S-M-L-XL-XXL-3XL

Colour:

047 orange with blue inserts

048 yellow with blue inserts

Single packed in a poly bag

Full box: 15 pcs.

50% Cotton



Segmented bands
heat-sealed



EN ISO
20471:2013 + A1:2016
EN ISO 13688:2013

08186N HV T-SHIRT

EN ISO 13688:2013

EN ISO 20471:2013 + A1:2016

A practical and light polo shirt certified with 50% cotton fabric in order to increase, in compliance with legal constraints, comfort and breathability. Heat-welded reflected bands.

Composition: 50% cotton piqué, 50% polyester

g/m²: 165

Band washing: 25

Sizes: S-M-L-XL-XXL-3XL

Colour:

047 orange inserts blue,

048 yellow inserts blue.

Single packed in a poly bag

Full box: 15 pcs.



EN ISO
20471:2013 + A1:2016
EN ISO 13688:2013

08184 HV BASIC POLO

EN ISO 13688:2013

EN ISO 20471:2013 + A1:2016

Economical polo shirt with reflective bands on chest and shoulders.

Composition: 100% polyester piqué

g/m²: 160

Band washing: 25

Sizes: S-M-L-XL-XXL-3XL

Colour:

012 yellow fluo, blue collar,

032 orange fluo, blue collar.

Single packed in a poly bag

Full box: 15 pcs.



EN ISO
20471:2013 + A1:2016
EN ISO 13688:2013

08183 HV BASIC T-SHIRT

EN ISO 13688:2013

EN ISO 20471:2013 + A1:2016

Basic T-shirt with reflective bands on chest and shoulders.

Composition: 100% polyester piqué

g/m²: 160

Band washing: 25

Sizes: S-M-L-XL-XXL-3XL

Colour:

012 yellow fluo,

032 orange fluo.

Single packed in a poly bag

Full box: 15 pcs.



120 g/m²



NEW
color orange



8450B
HI-VI SOFTSHELL LIGHT TROUSERS

EN ISO 13688:2013 - EN ISO 20471

Very light 4-WAY STRETCH softshell summer trousers (only 120 g/m²) certified for high visibility with heat-welded bands and knees pads holder. The garment has two front pockets, a side pocket with zip taped and concealed badge holder, a mobile phone pocket, two back pockets. Rear reinforcement to increase resistance. Supplied with adjustable belt.

Composition: 95% polyester, 5% spandex ponge. With dual function treatment: quick-drying water and expulsion of perspiration through the "3M SCOTCHGARD® Treatment" fabric.

g/m²: 120

Sizes: S-M-L-XL-XXL-3XL

Colour:

047 orange fluo with navy blue inserts,
048 yellow fluo with navy blue inserts.



Full box: 10 pcs.

NEW
color orange

120 g/m²



8454B
HI-VI SOFTSHELL LIGHT BERMUDA

EN ISO 13688:2013 - EN ISO 20471

Very light 4-WAY STRETCH softshell summer short trousers (only 120 g/m²) certified for high visibility with heat-welded bands. The garment has two front pockets, a side pocket with zip taped and concealed badge holder, a mobile phone pocket, two back pockets. Rear reinforcement to increase resistance. Supplied with adjustable belt.

Composition: 95% polyester, 5% spandex ponge. With dual function treatment: quick-drying water and expulsion of perspiration through the "3M SCOTCHGARD® Treatment" fabric.

g/m²: 120

Sizes: S-M-L-XL-XXL-3XL

Colour:

047 orange fluo with navy blue inserts,
048 yellow fluo with navy blue inserts.



Full box: 10 pcs.



M-PRO MULTI-PROTECTION clothing

With almost 60 years of experience in the production and distribution of PPE, we are pleased to present the new ISSALINE M-PRO project, a complete range of multi-purpose clothing. In developing this project we have been guided by the desire to offer, to those who work in areas of high risk, the maximum and most up-to-date protection against the important risks to which they are subject in carrying out their work. In line with what has just been said, PPE has in fact the maximum number of possible protections, resulting in the majority of cases Pentavalenti, ATEX and III Category certificates. Finally, the tradition accumulated in workwear helped us not to underestimate the aspects relating to comfort and wearability, non-secondary characteristics for those who must wear these garments for the whole day.



PLUS

- PERMANENT
- PENTAVALENT
- ATEX
- MULTI POCKETS
- METAL FREE

SWEAT



CE 0624

CAT. III
Reg. EU 2016/425

PLUS

- PERMANENT
- ATEX
- METAL FREE

POLO



CE 0624

CAT. II
Reg. EU 2016/425

STANDARD	 UNI EN ISO 11612:2015 A1-A2-B1-C2	 ISO 11611:2015 CLASS 1 - A1 - A2	 UNI EN 1149-5:2018	 IEC 61482-2 CLASS 1	 IEC 61482-2 2018 APC 1	 UNI EN 13034 2009 TIPO (PB) 6	 ATEX
WASHING CYCLE	Potentially infinite because permanent	Potentially infinite because permanent	Potentially infinite because permanent	Potentially infinite because permanent	Iron at 200° C AFTER EACH WASH	TREATMENT CAN BE RESTORED DURING WASHING	Potentially infinite because permanent

STANDARD	 UNI EN ISO 11612:2015 A1-B1-C1	 UNI EN 1149-5:2018	 ATEX
WASHING CYCLE	Potentially infinite because permanent	Potentially infinite because permanent	Potentially infinite because permanent

5585 PERMANENT M-PRO SWEATSHIRT

Long-sleeved sweatshirt, composed of two front and one back pieces, single-layered back yoke with back patch on the back, round sleeves, double-layered turtleneck collar, patch with pictograms in the right sleeve, central closure with plastic zip and double flap internal and external, the external flap is secured by a velcro fastening, 2 chest pockets and 2 pockets with zip fasteners at the waist and covered by flaps with velcro fastening, round sleeves, elastic cuffs, shuttle fabric lining contrast, bottom with elastic inserted.

Composition: 60% modacrilic 39% cotton 1% antistatic (carbon), weight 300 g/m²

Sizes: S-M-L-XL-XXL-3XL

Colour: 040 navy blue

Full box: 10 pcs.

5580 PERMANENT M-PRO LONG SLEEVES POLO

Long-sleeved shirt, made up of a front and a back piece, double-faced fabric half moon applied to the shoulders, small back loop applied on the back, patch with pictograms in the right sleeve, round sleeves arm hole, shirt collar in basic fabric double layers, closed on the front by flap-covered buttons with base fabric, wrist with 2 cm hem, hem with 2 cm hem and slits on the sides, back bottom longer than the front to offer more protection during movements.

Composition: 60% modacrilic 39% cotton 1% antistatic (carbon), weight 200 g/m²

Sizes: S-M-L-XL-XXL-3XL

Colour: 040 navy blue

Full box: 10 pcs.



PLUS





- PERMANENT
- QUADRIVALENT
- ATEX



Disponibile only on request

CE 0624

CAT. III
Reg. EU 2016/425

STANDARD	 UNI EN ISO 11612:2015 A1-B1-C1	 UNI EN 1149-5:2018	 IEC 61482-2 2018 APC 1	 UNI EN 13034 2009 TIPO PB 6	
	STANDARD 11612 FIRE / HEAT WASH NO. CERTIFIED	STANDARD 1149 ANTISTATIC NO WASH CERTIFIED	STANDARD 61482 ARCO ELECTRIC CERTIFICATE WASH N° *	STANDARD 13034 CHEMICAL CERTIFICATE WASH N° *	ATEX
WASHING CYCLE	Potentially infinite because permanent	Potentially infinite because permanent	Potentially infinite because permanent	Iron at 200° C AFTER EACH WASH TREATMENT CAN BE RESTORED DURING WASHING	Potentially infinite because permanent

5577 PERMANENT M-PRO SHIRT *Only on demand*

The shirt is composed of two front quarters and a back part, back yoke applied, rear small fabric loop, shirt collar with double layer fabric, patch with pictograms in the right sleeve, 2 pockets on the chest covered with flaps stopped by an automatic metal button, round sleeves arm hole, cuffs closed with metal snap fasteners composed of double fabric, covered slit of the shirt's wrist, bottom of the shirt with side vents, there are no visible metal parts on the outside that can touch the body of the wearer inside.

Composition: 60% modacrilic 39% cotton 1% antistatic (carbon), weight 180 g/m²

Sizes: S-M-L-XL-XXL-3XL

Colour: 040 navy blue

Full box: 10 pcs.







PLUS

- PENTAVALENT
- ATEX
- MULTI POCKETS



CE 0624

CAT. III
Reg. EU 2016/425

STANDARD	 UNI EN ISO 11612:2015 A1-B1-C1-E1-F1	 ISO 11611:2015 CLASS 1 - A1 - A2	 UNI EN 1149-5:2018	 IEC 61482-2 2018 APC 1	 UNI EN 13034 2009 TIPO 6	
	STANDARD 11612 FIRE / HEAT WASH NO. CERTIFIED	STANDARD 11611 WELDING N° WELDER CERTIFIED	STANDARD 1149 ANTISTATIC NO WASH CERTIFIED	STANDARD 61482 ARCO ELECTRIC CERTIFICATE WASH N° *	STANDARD 13034 CHEMICAL CERTIFICATE WASH N° *	ATEX
WASHING CYCLE	30	30	30 (Potentially infinite because permanent)	30	30 Iron at 200° C AFTER EACH WASH TREATMENT CAN BE RESTORED DURING WASHING	30

5530 M-PRO TROUSERS

The trouser is made up with two parts in front and two parts in the back, elastic waist on the back side, on the waist band there are 5 belt loops, 2 side pockets french style with flaps fixed with velcro closure, 1 back pocket with flap fixed with velcro closure, 1 ruler pocket covered with flap fixed with velcro closure on the right side, patch pocket with flap fixed with velcro on the left side, all the pockets sack lining are made with self main fabric.

Composition: 98% cotton 2% antistatic (carbon), weight 280 g/m²

Sizes: S-M-L-XL-XXL-3XL

Colour: 040 navy blue

Full box: 10 pcs.







PLUS

- PENTAVALENT
- ATEX
- MULTI POCKETS



CE 0624

CAT. III
Reg. EU 2016/425

STANDARD	 UNI EN ISO 11612:2015 A1-B1-C1-E1-F1	 ISO 11611:2015 CLASS 1 - A1 - A2	 UNI EN 1149-5:2018	 IEC 61482-2 2018 APC 1	 UNI EN 13034 2009 TIPO 6	
	STANDARD 11612 FIRE / HEAT WASH NO. CERTIFIED	STANDARD 11611 WELDING N° WELDER CERTIFIED	STANDARD 1149 ANTISTATIC NO WASH CERTIFIED	STANDARD 61482 ARCO ELECTRIC CERTIFICATE WASH N° *	STANDARD 13034 CHEMICAL CERTIFICATE WASH N° *	ATEX
WASHING CYCLE	30	30	30 (Potentially infinite because permanent)	30	30 Iron at 200° C AFTER EACH WASH TREATMENT CAN BE RESTORED DURING WASHING	30

5050 M-PRO JACKET

The jacket is made up with two front parts, 1 back part, the bottom part has two layer fabric, patch with pictograms in the right sleeve, the collar like shirt, front metal zipper closing covered to the body and to the outside with two flaps, outer flaps fixed with metal snap buttons, 1 chest pocket with flap fixed with velcro closure, 2 waist pockets with flap fixed with velcro closure, sleeves with round arm hole, cuff with elastic.

Composition: 98% cotton 2% antistatic (carbon), weight 280 g/m²

Sizes: S-M-L-XL-XXL-3XL

Colour: 040 navy blue

Full box: 10 pcs.







PLUS

- PENTAVALENT
- ATEX
- MULTI POCKETS



CE 0624

CAT. III
Reg. EU 2016/425

STANDARD	 UNI EN ISO 11612:2015 A1-B1-C1-E1-F1	 ISO 11611:2015 CLASS 1 - A1 - A2	 UNI EN 1149-5:2018	 IEC 61482-2 2018 APC 1	 UNI EN 13034 2009 TIPO 6	
	STANDARD 11612 FIRE / HEAT WASH NO. CERTIFIED	STANDARD 11611 WELDING N° WELDER CERTIFIED	STANDARD 1149 ANTISTATIC NO WASH CERTIFIED	STANDARD 61482 ARCO ELECTRIC CERTIFICATE WASH N° *	STANDARD 13034 CHEMICAL CERTIFICATE WASH N° *	ATEX
WASHING CYCLE	30	30	30 (Potentially infinite because permanent)	30	30 Iron at 200° C AFTER EACH WASH TREATMENT CAN BE RESTORED DURING WASHING	30

5070 M-PRO COVERAL

The coverall is made up with two front parts, 1 back part of the body, legs made up with two parts, patch with pictograms in the right sleeve, the collar like shirt, front metal zipper closing covered to the body and to the outside with two flaps, outer flaps fixed with metal snap buttons, 1 chest pocket with flap fixed with velcro closure, 2 waist pockets with flap fixed with velcro fastening x 2, sleeves with round arm hole, cuff with elastic, back elastic on waist, cuff with elastic, 1 ruler pocket covered with flap fixed with velcro closure on the right side.

Composition: 98% cotton, 2% antistatic (carbon), weight 280 g/m²

Sizes: S-M-L-XL-XXL-3XL

Colour: 040 navy blue

Packaging: 10 pcs.



PLUS

- PROBAN
- TESTE 50 LAVAGE ET 15025 (FLAME)
- ATEX

CE 0624

CAT. III
Reg. EU 2016/425

PROBAN

STANDARD		PERMANENT 		
	UNI EN ISO 11612:2015 A1-B1-C1	UNI EN 1149-5:2018	UNI EN 13034 2009 TIPO P8 6	
	STANDARD 11612 FIRE / HEAT WASH NO. CERTIFIED	STANDARD 1149 ANTISTATIC NO WASH CERTIFIED	STANDARD 13034 CHEMICAL CERTIFICATE WASH N°	ATEX



5075 SHIRT M-PRO PROBAN

The shirt is composed of two front quarters and a back part, back joke applied with double fabric, rear small fabric loop, shirt collar with double fabric, 2 pockets on the chest covered with flaps stopped by an automatic metal button, round sleeves arm hole, cuffs closed with metal snap fasteners composed of double fabric, covered crepe, bottom of the shirt with side vents, CON bottom of the shirt with side vents. Pictogram shield on the right arm. There are no visible metal parts on the outside that can touch the body of the wearer inside.

Composition: 79% cotton 20% polyester 1% antistatic (carbon), weight 180 g/m²

Sizes: S-M-L-XL-XXL-3XL

Colour: 040 navy blue

Full box: 10 pcs.

PLUS

- HEXAVALENT
- 6 POCKETS
- ATEX

CE 0624

CAT. III
Reg. EU 2016/425

STANDARD		PERMANENT 					
	UNI EN ISO 14116:2015 INDEX 1	UNI EN 1149-5:2018	UNI EN 13034 2009 TIPO 6		UNI EN ISO 20471:2017 CL. 3	EN 343:2019 3/1	UNI EN 14058:2017 CL. 3
	STANDARD 14116 FIRE WASHES FROM CERTIFICATE	STANDARD 1149 ANTISTATIC NO WASH CERTIFIED	STANDARD 13034 CHEMICAL CERTIFICATE WASH N°	ATEX	STANDARD 20471 HI-VIS CERTIFICATE WASHING NUMBER	STANDARD 343 RAIN N° WASHING OF THE CERTIFICATE	STANDARD 14058 COLD WASH OF THE CERTIFICATE

5090 PARKA M-PRO

Two-tones parka made up of 6 parts in front and 2 rear parts, lower body and sleeves in contrast color, the front has two pockets with internal concealed sack on the chest covered with flaps stopped by velcro, and 2 patch pockets at the waist closed by flaps stopped by velcro, patch with pictograms in the right sleeve, 2 reflective bands surround the waist and each sleeve, 2 reflective bands connect the front and back torso bands passing through the shoulders, all bands are sewn with double stitched thread, fully lined and concealed hooded collar lined with 3 index fabric, removable hood, inside the garment is completely lined with index 3 fabric, thermal lining in fireproof material, waist adjustment with drawstring, front quarters provided with two inside patch pockets and closed by tear tape, central closure with zip covered by triple anti-wind flap of which the external one stopped with velcro, the inside in the bottom part it is lined with waterproof fabric to prevent the parka from getting wet by capillarity the wrist ends with a 2 cm hem, the wrists are provided with inside elasticated windproof cuffs.

Composition: outer fabric 98% polyester coated with polyurethane 2% antistatic (carbon), weight 260 g/m², lining 100% cotton, weight 160 g/m²

Sizes: S-M-L-XL-XXL-3XL

Colour: 048 yellow fluo/navy blue inserts

Full box: 5 pcs.

PLUS

- TRIVALENT
- ATEX
- 120 g/m²

CE 0624

CAT. II
Reg. EU 2016/425



STANDARD		PERMANENT 		
	UNI EN ISO 14116:2015 INDEX 1	UNI EN 1149-5:2018		UNI EN ISO 20471:2017 CL. 2
	STANDARD 14116 FIRE WASHES FROM CERTIFICATE	STANDARD 1149 ANTISTATIC NO WASH CERTIFIED	ATEX	STANDARD 20471 HI-VIS CERTIFICATE WASHING NUMBER

5010 VEST M-PRO

Vest made in one piece sewn onto the shoulders, fully edged with the same basic fabric, 7 mm hem, sewn-on appliqué bands on the bust, pictogram patch on the left chest, this garment is metal-free.

Composition: 99% polyester 1% antistatic (carbon), weight 120 g/m²

Sizes: L (M/L) - XXL (XL/XXL)

Colour: 012 yellow fluo

Full box: 25 pcs.





04681 ISOTHERMIC JACKET

EN 342:2017 - EN ISO 13688:2013

Certified EN 342:2004 for low temperatures (combined with trousers 04636). Suited for work in cold-storage rooms. Very high collar with adjustable fastening, soft fleece lining. Breast and sleeve pockets and two side pockets with flaps and buttons. Knitted stretch cuff. Zip fastener with double slide, covered by a flap fastened with Velcro. Reflector strips on the chest and at the bottoms of the trousers for better visibility in steam or fog. Elasticised waistband.

Composition:

Outer: polyamide, padding: double layer of thinsulate 100G separated by a layer of polyester. Elastic waistband. **lining:** 100% polyester

Sizes: S-M-L-XL-XXL

Colour: 040 blue

Single packed in a poly bag - **Full box:** 5 pcs.



04636 ISOTHERMIC TROUSERS

EN 342:2017 - EN ISO 13688:2013

Certified EN 342:2004 for low temperatures (combined with jacket 04681). Suited for work in cold-storage rooms. Very high waisted, with adjustable elastic on the shoulders. Long zip fasteners covered with a flap at the sides of the trousers, so that the suit can be put on without taking off shoes. Handy pockets at the knee, which act as reinforcement and can also hold separately supplied padding. Reflector strip at the bottom.

Composition:

Outer: polyamide, padding: double layer of thinsulate 100G separated by a layer of polyester, **lining:** 100% polyester

Sizes: S-M-L-XL-XXL

Colour: 040 blue

Single packed in a poly bag - **Full box:** 5 pcs.



04675 COLD-WEATHER COVERALLS

CE CAT. I - EN ISO 13688:2013

Heavy padded coveralls. Detachable padded hood, knitted collar, three zipped pockets, sleeve bottom inner cuffs, elastic waistband, side long zipper opening, leg bottom elastic to fasten it to shoes.

Composition: nylon with polyester filling and stitched nylon lining.

Sizes: S-M-L-XL-XXL-3XL

Colour: 040 blue

Single packed in a poly bag
Full box: 5 pcs.



04680 COLD-WEATHER JACKET

CE CAT. I - EN ISO 13688:2013

Heavy padded jacket. Collar lined with artificial fur, three outer pockets, front zipper closure covered by flap with velcro.

Composition: nylon with polyester filling and stitched nylon lining.

Sizes: S-M-L-XL-XXL

Colour: 040 blue

Single packed in a poly bag
Full box: 5 pcs.



04635 COLD-WEATHER TROUSERS

CE CAT. I - EN ISO 13688:2013

Heavy padded trousers, with adjustable elastic shoulder braces, two zippered pockets, front zipper closure, side long zipper opening, leg bottom elastic to fasten it to shoes.

Composition: nylon with polyester filling and stitched nylon lining.

Sizes: S-M-L-XL-XXL

Colour: 040 blue

Single packed in a poly bag
Full box: 5 pcs.



Refrigue®

Isotermici - Refrigue®



P542 only on request ISOTHERMAL SUIT

EN 342

For low temperature.

Sizes: S-M-L-XL-XXL.

Colour: 040 blue

Single packed in a poly bag
Full box: 1 pc.



P40 only on request ISOTHERMIC CAP

EN 342

For low temperature.

Sizes: one size.

Colour: 040 blue

Single packed in a poly bag
Full box: 1 pc.



P394 only on request ISOTHERMAL JACKET

EN 342

For low temperature.

Sizes: S-M-L-XL-XXL.

Colour: 040 blue

Single packed in a poly bag
Full box: 1 pc.



P297 only on request ISOTHERMAL TROUSERS

EN 342

For low temperature.

Sizes: S-M-L-XL-XXL.

Colour: 040 blue

Single packed in a poly bag
Full box: 1 pc.





FORESTRY CLOTHING

A workwear line certified EN 381 designed for workers exposed to the risk of cuts from portable chain saws. The presence of a fiber with high tenacity in the padding of the protected parts ensures that the chain saw instantly blocks. Cut and packaging are designed to give maximum comfort and convenience to the wearer. The range is completed with specific footwear and gloves. It can be customized with serigraphy or iron on labels.

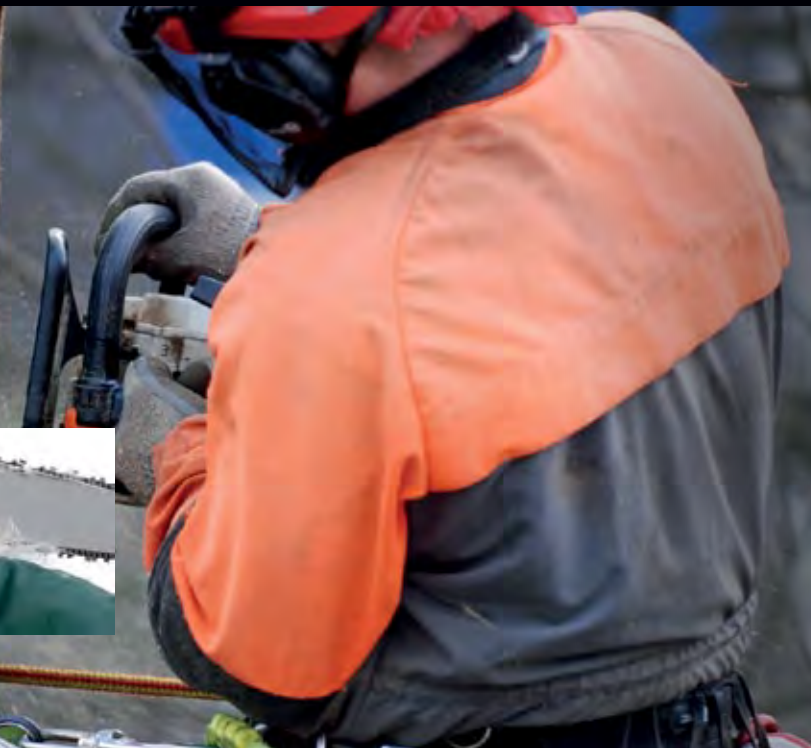

Class 1: 20 m/s +/- 0.2 m/s

08950N CHAINSAW JACKET

CAT. III

EN ISO 11393-6 (Class 1: 20 m/s +/- 0.2 m/s)

the chest, shoulders and arm protection. Bellows and ventilation on the back, zip closure.

Composition: 68% polyester, 32% cotton

Sizes: M-L-XL-XXL-3XL

Colour: green / orange.

Single packed in a poly bag

Full box: 1 pc.



Class 1: 20 m/s +/- 0.2 m/s

08935N BIB PANTS

CAT. III

EN ISO 11393-2 (Class 1: 20 m/s +/- 0.2 m/s)

Protection on the front of the leg at 180° + 5 cm. Elastic waist belt, adjustable elastic braces with plastic buckle. Pocket on the harness with zip closure, two pockets on the trousers and a back pocket.

Composition: 68% polyester, 32% cotton

Sizes: M-L-XL-XXL

Colour: green / orange.

Single packed in a poly bag

Full box: 1 pc.



Class 1: 20 m/s +/- 0.2 m/s

08940N CHAINSAW COVER PANTS

CAT. III

EN ISO 11393-2 (Class 1: 20 m/s +/- 0.2 m/s)

Protection on the front of the leg at 180° + 5 cm. Total lateral openings on the legs by zips and a center zip that allows you to separate them. Belt loops.

Composition: 68% polyester, 32% cotton

Sizes: L (M/L) - XXL (XL/XXL)

Colour: green / orange.

Single packed in a poly bag

Full box: 1 pc.



3122XX

CLASSE 2: 24 m/s

07590 CHAINSAW CUT-RESISTANT GLOVES

EN 420:2003 + A1:2009 CAT.: III

EN 388:2016 3122XX

EN 281-7:1999 CLASSE 2 : 24 m/s

N.B. PROTECTION E CERTIFICATE ONLY ON BACK OF LEFT GLOVE.

This product has been manufactured in accordance with the requirements of the EU Regulation 2016/425, for basic use, according to: EN 420:2003+A1:2009, general requirements, EN 388:2016, against mechanical risks and EN 381-7:1999 against risks due to chain saw cutting, applicable to it in accordance with certificate No. 18/0895/00/0161 de AITEX, Plaza Emilia Sala No. 1, Aloy, Spain, notified body 0161.

Sizes: 9-10-11

Full box: 5 pa.



S25 COMPLETE SUIT

EN397 - EN1731

Centurion helmet Concept in ABS orange, ultralight with Terylene harness and highly breathable Hydroflock sponge. Electrically resistant according to EN 50365. Ear defenders with noise reduction of 25 dB, and a metal forestry visor EN 1731 (model S59) covered in Nylon.

Colour: O30 orange.

Kit in box

Full box: 1 pc.



KIT AKROBAT

page 130



PIP

**VEST
HEATING**

Revolutionary
Heating
Technology



Protect yourself from the cold by moving freely



LONG LIFE HEAT - ULTRA LIGHT FIT

- **Designed to heat and maintain internal body temperature**, breathable softshell material provides pleasant warmth, comfort and versatility.
- **Flexible heating panels integrated in chest and back**, guarantee a long-lasting and reliable heat with the simple pressure of a button.
- **Active fit in one size, which includes velcro straps with closure two-way**, easy to adjust for a safe and comfortable fit for any type of build.
- **With three heat settings available at the touch of a button.**

The durable 5V/2A rechargeable battery enables you to work with fast and effective heat to warm your chest and back in seconds. To be worn over a shirt.

- **Effective heat for up to 4 hours on a single charge**, at the lowest setting with appropriate outer clothing.



Remote control operation with multiple heat levels.



399-HVRE (replacement)
Remote control for thermal gilet.
In box: 1 pc.
Full box: 50 pcs.



399-HVBAT (replacement)
Battery for thermal gilet, mini Power bank 5Volt/2A rechargeable with USB cable.
In box: 1 pc.
Full box: 60 pcs.

**300-HV100
HEATING WAISTCOAT**

Including battery and remote control.
With adjustable Velcro fastener.
Three adjustable heating levels with remote control. Activation time 90-120 seconds. Warm-up time 4 hours (see specifications).
Works with Mini Power Bank 5Volt/2A rechargeable battery with USB cable (included).

Composition: nylon
Sizes: adjustable one size
Colour: black
In box: 1 pc.
Full box: 12 pcs.

Refreshing relief in warmer temperatures

**396-EZ900
EZ-COOL® MAX
EVAPORATIVE COOLING WIPE *Only on request***

Before being wearing, it must be immersed in water and activated by shaking it in the air. After worn it quickly provides a cooling effect by lowering the temperature. It offers UV protection and is odour-resistant. Reusable and machine washable.

Applications: Ideal for use in hot environments to protect against the stress of high temperatures.
Maintenance: Machine wash gently with mild soap.

Composition: 55% Nylon, 45% Polyester
Sizes: unnnique size 54cm x 48cm x 36cm
Colour: navy blue

In a ready-made box, which can be clipped onto the belt or uniform: 1 pc.
Full box: 48 pcs.

Wipe
refreshing
evaporative

NEW





DISPOSABLE COVERALLS



08270N ISSALINE BASIC

CE CAT. I - EN ISO 13688:2013

Semi-durable in SSP polypropylene With hood, back pocket, elastic in: hood, wrists, waist, ankles.

Composition: SPP polypropylene

g/m²: 32

Sizes: M-L-XL-XXL

Colour: 050 white.

Single packed in a poly bag

Full box: 25 pcs.



In a hangable envelope

SMS



EN ISO 13688:2013
TIPO 5 EN 13982:2004 + A1:2010 • TIPO 6 EN 13034:2005 + A1:2009



08288 ISSALINE CHEM AIR

CAT. III Type 5,6 - Reg. EU2016/425

Disposable overall in third category with zipper covered by a flap; in order to protect the zipper from the entry of toxic dust there is a double-sided adhesive along the entire flap. Elasticated wrists, ankles and along the cap. Sms fabric privileges breathability over microporous film.

Composition: multilayer SMS

g/m²: 45

Sizes: S-M-L-XL-XXL-3XL

Colour: 050 white.

Single packed in a poly bag

Full box: 25 pcs.



In a hangable envelope

NEW LIGHT

MICRO-POROUS FILM

EN ISO 13688:2013



08289 ISSALINE CHEM LIGHT

CAT. III Type 5,6 - Reg. EU2016/425

One use in third category with zipper covered by flap; to protect the hinge from toxic dust ingress there is a double-sided adhesive along the entire flap. Elasticated cuffs, ankles and along the hood for better insulation, the hood is divided into three parts for a better grip.

Composition: microporous polypropylene and polyethylene film

g/m²: 47

Sizes: S-M-L-XL-XXL-3XL

Colour: 050 white.

Single packed in a poly bag

Full box: 50 pcs.



In a hangable envelope



MICRO-POROUS FILM



08290 ISSALINE CHEM

CAT. III Type 5,6 - Reg. EU2016/425

Disposable overall in third category with zipper covered by a flap; in order to protect the zipper from the entry of toxic dust there is a double-sided adhesive along the entire flap. Elasticated wrists, ankles and along the cap for better insulation, the cap is divided into three parts for better adherence.

Composition: Microporous film Polypropylene and polyethylene
g/m²: 65

Sizes: S-M-L-XL-XXL-3XL

Colour: 050 white.

 Single packed in a poly bag

Full box: 25 pcs.



In a hangable envelope

TAPED MICRO-POROUS FILM



08292 ISSALINE CHEM PLUS

CAT. III Type 5,6 - Reg. EU2016/425

Disposable overall in third category with zipper covered by a flap; in order to protect the zipper from the entry of toxic dust there is a double-sided adhesive along the entire flap. Elasticated wrists, ankles and along the cap for better insulation, the cap is divided into three parts for better adherence. Taped zippers to protect against tiny toxic dust (e.g. asbestos) and sprayed chemicals.

Composition: Microporous film Polypropylene and polyethylene
g/m²: 65

Sizes: S-M-L-XL-XXL-3XL

Colour: 050 white.

 Single packed in a poly bag

Full box: 25 pcs.



In a hangable envelope

APRONS

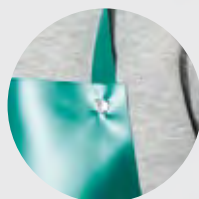

Light
75 x 100



Heavy
75 x 120



Heavy
100 x 115



MADE IN ITALY 

PRODUCT'S PROTECTION Internal production. 

Features: made of 2 tear-resistant fabrics, with laces and collar of the same fabric.

Composition:

L = light 1313 polyester polyamide, PVC coated on both sides

P = heavy polyester polyamide, heavy PVC coated on both sides

Items	Fabric	cm.	Colour	Packing
00801	Light	75 x 100	(020) Green - (050) White	20 pcs.
00801P	Heavy	75 x 100	(020) Green - (050) White	10 pcs.
00810	Light	75 x 120	(020) Green - (050) White	20 pcs.
00810P	Heavy	75 x 120	(020) Green - (050) White	10 pcs.
00815	Light	100 x 115	(020) Green - (050) White	10 pcs.
00815P	Heavy	100 x 115	(020) Green - (050) White	10 pcs.

Imported product

Features: in two tear-resistant fabrics, packed with ties and collar.

Composition: PVC/Poly/PVC

Items	Fabric	cm.	Colour	Packing
00805	0,45	75 x 110	(020) Green - (050) White	20 pcs.
00820	0,45	90 x 120	(020) Green - (050) White	20 pcs.



00129
LLUVIA PU RAINCOAT

Foldaway hood, back and armpit ventilation, plastic zipper closure with flap and buttons, windproof cuffs, two pockets with rainproof flap, buttons cuff.

Composition: PU/PVC/polyester

Sizes: M-L-XL-XXL

Colour: 020 green

Full box: 10 pcs.



00239
LLUVIA PU TROUSERS

Elastic waistband with drawstring, leg bottom bellows with zipper.

Composition: PU/PVC/polyester

Sizes: M-L-XL-XXL

Colour: 020 green

Full box: 10 pcs.



00209
LLUVIA PU RAINSUIT (JACKET TROUSERS)

Jacket: foldaway hood, back and armpit ventilation, plastic zipper closure with flap and buttons, windproof cuffs, two pockets with rainproof flap, buttons cuff. **Trousers:** elastic waistband with drawstring, leg bottom bellows with zipper.

Composition: PU/PVC/polyester

Sizes: M-L-XL-3XL

Colour: 010 yellow, 020 green, 040 blue

Full box: 10 sets



01700
RAINSUIT (JACKET TROUSERS)

Jacket: fixed concealed hood, back and armpit ventilation, fastener with plastic zipper, windproof cuffs, two pockets with rainproof flap. Taped seams.

Trousers: elastic waistband, two muff pockets, leg bottom snap button. Taped seams. Folded up in practical pouch with zipper.

Composition: PVC coated polyester

Sizes: S-M-L-XL-3XL

Colour: 010 yellow, 020 green, 040 blue

Full box: 10 set.



01702
RAINCOAT

Fixed concealed hood, back and armpit ventilation, fastener with double buttons system, windproof cuffs, two pockets with rainproof flap. Taped seams. Folded up in practical pouch with zipper.

Composition: PVC coated polyester

Sizes: S-M-L-XL-XXL

Colour: 010 yellow, 020 green, 040 blue

Folded in a handy zippered pouch.

Full box: 10 pcs.



01510
PONCHO

Foldable inside belt-bag, elastic strap with quick fastening buckles, snap buttons on side. Fixed hood with coulisse. Taped seams.

Composition: PVC coated polyester

Sizes: one size

Colour: 020 green

Full box: 25 pcs.



ISSALINE

BY PIP

Hand protection

Hand protection is essential to ensure safety in the workplace. The human hand is composed of bones, muscles, and joints and performs various work activities, from the heaviest to the most delicate. Approximately one third of workplace injuries involve the hands, so it is necessary to use appropriate protective devices.

Hand injuries can include cuts, burns, and chemical injuries. Each accident can have health consequences and result in high costs. Using the right gloves can offer effective protection. Depending on the work activities carried out, there are different types of injuries that can be sustained: cuts, abrasions, burns, or blisters; burns or chemical irritations; thermal burns caused by heat; cold-related damage such as frostbite or frostnip.

It is important to understand the risks present and wear gloves specifically designed to protect against different injuries. There are different types of work gloves to protect hands from various hazards: leather gloves, cotton and knit gloves, synthetic materials such as polymer or polyacrylic. Depending on the specific application, there are gloves for welders, for dry or oily/wet-dry areas, cut-resistant gloves, heat or cold protective gloves, gloves for electricians, and for chemical agents. Depending on the duration of use, there are disposable or multi-purpose gloves.

When selecting protective gloves, consider the environment in which they will be used, whether dry or wet and oily. Gloves should provide delicacy and precision for specific tasks or be suitable for heavy work. Take into account the potential risks the gloves must protect against. To meet different needs, gloves are made from different materials, including latex alternatives for allergic individuals.

The PPE Directive defines three categories of hand protection: Category I for minimal risks such as household gloves, Category II for medium-level risks such as cut wounds (must have the CE mark), and Category III that provides protection against mortal risks or irreversible injuries (must undergo certification).

There are specific standards that regulate hand protection, including various resistance tests, manufacturer labeling, and information provided by the supplier. Additionally, there are specific product standards such as EN 388 for mechanical protection, EN 407 for heat, EN 511 for cold, EN 374 for chemicals and microorganisms, and EN 12477 for welding.

For more information, refer to the specific regulations in the last pages of this catalog.

Note: The certification values shown in this catalogue may vary due to the continuous updating process; for exact data, please ask for updated technical data sheet.



All for one, one for all? Better to use the right glove.

Iconography of use

This table gives general recommendations to facilitate the choice of gloves according to the work activity. However, it is only a general recommendation not to be taken literally and, especially in medium to high risk situations, require more in-depth analysis or advice of competent personnel.



Gloves packaged in a personalised hangable envelope



Gloves packaged in blister in cardboard recyclable and very often recycled.

CODE	Logistics	Construction	Carpentry	Maintenance	Mechanical maintenance	Heavy industry	Gardening	Hydraulics	Glassworks	Handling of small parts	Electronics	Outdoor work (cold)	Working with cutting tools mechanical carpentry	Wet or oiled parts	Cleaning and disinfection	Welding and heat	Assembly	Automotive industry
07104	●	●	●		●	●	●	●										
07112	●	●	●		●		●											
07117	●	●	●		●	●												
07121						●										●		●
07121K						●												
07122						●										●		●
07127						●										●		●
07129	●	●	●	●	●		●	●								●		●
07131		●	●	●	●		●	●										
07134		●	●	●	●		●											
07138		●	●	●	●		●											
07139	●	●	●	●	●		●	●										
07140	●	●	●	●	●		●	●										
07155	●	●			●			●										
07165	●	●				●	●					●		●				
07208	●		●		●		●			●	●							●
07215					●					●	●							●
07218					●									●	●			
07225						●								●	●			
07227						●								●	●			
07230						●								●				
07244	●	●	●		●		●					●		●				
07245	●	●			●		●	●		●		●		●	●			●
07252N	●			●	●									●	●			
07253	●			●	●							●		●				
07255	●	●	●				●					●		●				
07256	●	●	●		●		●	●										
07260		●	●		●	●		●										
07260T		●	●		●	●		●										
07265		●	●		●	●		●										
07270		●	●		●	●		●										
07270T		●	●		●	●		●										
07275		●	●		●	●		●										
07278	●	●	●	●	●		●	●										
07279	●	●	●	●	●		●	●						●				●
07280		●	●		●	●								●				●

LOOK AT G-TEK® GLOVES

LOOK AT G-TEK® GLOVES



CODE	Logistics	Construction	Carpentry	Maintenance	Mechanical maintenance	Heavy industry	Gardening	Hydraulics	Glassworks	Handling of small parts	Electronics	Outdoor work (cold)	Working with cutting tools mechanical carpentry	Wet or oiled parts	Cleaning and disinfection	Welding and heat	Assembly	Automotive industry
07280T		•	•		•	•												
07282	•			•	•			•										
07283	•				•	•												
07284	•	•	•		•		•	•		•				•				
07284DP	•	•	•		•		•	•		•				•				
07285	•	•	•		•		•	•		•				•				
07286	•	•	•	•	•		•	•		•	•							
07286DP	•	•	•	•	•		•	•		•	•							
07287	•	•	•	•	•		•	•		•	•							
07288	•				•	•		•		•				•				•
07289	•	•		•	•		•	•		•				•				•
07290										•				•				•
07291										•				•				•
07300		•			•													•
07305		•			•													•
07315		•			•													•
07360	•				•	•		•										
07362	•				•	•		•										
07590																		
17010	•	•	•		•		•	•										
17131	•	•	•	•	•		•	•										
17131T																		
17140	•	•	•	•	•		•	•										
17140T	•	•	•	•	•		•	•										
17212										•	•						•	•
17276	•	•	•	•			•	•		•	•						•	
17281	•									•				•				•
17284	•	•	•		•		•	•		•				•				•
17286	•	•	•	•	•		•	•		•				•				•
17287	•	•	•	•	•		•	•										
17289	•	•		•	•		•	•						•				
17320												•						
17364	•	•	•		•		•	•						•				
17365	•	•			•		•	•										
17366	•	•	•		•		•	•										

LOOK AT G-TEK® GLOVES

LOOK AT G-TEK® GLOVES



NEW
saving
package



07286DP 080
NITRILE
EN 388 3121X

The glove has excellent sensitivity and excellent resistance mechanically resistant to abrasion and tearing.

Yarn: polyester

gauges: 13

Yarn colour: white

Coating: Nitrile

Coating colour: grey

Sizes: 8-9-10

Package: 12 pa. (not individually wrapped)

Full box: 240 pa.



07286 080
NITRILE
EN 388 3121X

The glove has excellent sensitivity and excellent resistance mechanically resistant to abrasion and tearing.

Yarn: polyester

gauges: 13

Yarn colour: white

Coating: Nitrile

Coating colour: grey



envelope without graphics

Sizes: 8-9-10

Full box: 240 pa.

NEW



07286 060
NITRILE
EN 388 3121X

The glove has excellent sensitivity and excellent resistance mechanically resistant to abrasion and tearing.

Yarn: polyester

gauges: 13

Yarn colour: black

Coating: Nitrile

Coating colour: black



envelope without graphics

Sizes: 8-9-10

Full box: 240 pa.



07286 010
NITRILE
EN 388 3121X

The glove has excellent sensitivity and excellent resistance mechanically resistant to abrasion and tearing.

Yarn: polyester

gauges: 13

Yarn colour: yellow

Coating: Nitrile

Coating colour: grey



envelope without graphics

Sizes: 8-9-10

Full box: 240 pa.



07287 080
STRONG CATCH
EN 388 4121A

The glove has excellent sensitivity and excellent resistance mechanically resistant to abrasion and tearing.

Yarn: poly / nylon

gauges: 13

Yarn colour: white

Coating: Nitrile

Coating colour: grey



poly bag

Sizes: 7-8-9-10

Full box: 120 pa.

**TOP
QUALITY**



17287 030
STRONG CATCH
blister

The glove has excellent sensitivity and excellent resistance mechanically resistant to abrasion and tearing.

Yarn: poly / nylon

gauges: 13

Yarn colour: orange

Coating: Nitrile

Coating colour: blue



blister

Sizes: 7-8-9-10

Full box: 60 pa.

07287 030 **only on request**
STRONG CATCH
EN 388 3121X

The glove has excellent sensitivity and excellent resistance mechanically resistant to abrasion and tearing.

Yarn: poly / nylon

gauges: 13

Yarn colour: orange

Coating: Nitrile

Coating colour: blue



poly bag

Sizes: 7-8-9-10

Full box: 120 pa.



34-M1001/FC-ET
pag. 122



07288 060
OIL CATCH
EN 388 2121A

Gloves made with spunbonded nylon thread, with nitrile coating, backs fully coated with nitrile. The gloves have excellent sensitivity and excellent mechanical resistance to abrasion and tear. The nitrile coating on the backs makes the gloves particularly suitable for all kinds of work in dirty and greasy environments, e.g. handling in the presence of oil.

Yarn: poly / nylon
gauges: 13
Yarn colour: black
Coating: Nitrile
Coating colour: black



poly bag
Sizes: 7-8-9-10-11
Full box: 120 pa.



07282 080
FOAM CATCH
EN 388 4121X

Gloves made of spunbonded nylon thread, with palms coated with nitrile foam. Excellent sensitivity and good mechanical strength. The foam treatment ensures micro porosity to the nitrile combining breathability and water resistance (including oils).

Yarn: poly / nylon
gauges: 13
Yarn colour: white
Coating: Nitrile foam
Coating colour: grey



poly bag
Sizes: 6-7-8-9-10
Full box: 120 pa.



07283 040
SANDY CATCH
EN 388 4121X

Gloves made of spunbonded nylon thread, with palms coated with nitrile foam. The "sand" effect gives the gloves a secure grip when handling oily parts. The gloves have excellent sensitivity and good resistance to abrasion. The foam treatment ensures micro porosity to the nitrile combining breathability and water resistance (including oils).

Yarn: poly / nylon
gauges: 13
Yarn colour: blue
Coating: Nitrile "sand" effect
Coating colour: blue



poly bag
Sizes: 7-8-9-10
Full box: 120 pa.



17276 010
GRITTY CATCH
EN 388 4131X

15 gauges continuous thread glove, palm coated in NITRIL with "sandblasted" effect for excellent grip even in the presence of slippery liquids such as various oils. Excellent abrasion resistance.

Yarn: poly / nylon
gauges: 15
Yarn colour: yellow fluo
Coating: Nitrile "sand" effect
Coating colour: blue royal



blister
Sizes: 7-8-9-10
Full box: 60 pa.



07360
DOTS CATCH
EN 388 3121B

Technical gloves made with 15 gauges spunbonded nylon/spandex fabric, coated with nitrile foam up to ¾ of the backs; the "Slip dots" on the palms ensure high gripping even when handling greasy items. The end result is sensitive, oil-resistant, breathable gloves with a very good grip.

Yarn: nylon / spandex
gauges: 15
Yarn colour: grey
Coating: Nitrile foam
Coating colour: black



poly bag
Sizes: 7-8-9-10-11
Full box: 120 pa.



07362
ORANGE DOTS CATCH
EN 388 4121X

Technical glove in polyester /spandex 13-gauge continuous thread with nitrile foam coating, nitrile foam coating with pvc dots guarantee a secure grip even when handling oily objects. The final result is a sensitive, oil-proof, breathabilityglove with an excellent grasp.

Yarn: polyester / spandex
gauges: 13
Yarn colour: orange
Coating: Nitrile
Coating colour: black with orange dots



poly bag
Sizes: 8-9-10-11
Full box: 120 pa.



SAFETY GLOVES



**18
gauges**



**07278 080
EASY CATCH
EN 388 4121X**

Technical gloves that provide excellent sensitivity, the mixed NITRILE/PU foam lining makes them very breathable and resistant to oils.

Yarn: nylon
gauges: 18
Yarn colour: blue
Coating: Nitrile/PU foam
Coating colour: black



poly bag
Sizes: 7-8-9-10-11
Full box: 120 pa.

**18
gauges**



**07279 040
LIGHT CATCH
EN 388 4121X**

Glove in continuous thread coated in nitrile with 18 gauges processing that allows excellent sensitivity and lightness, the nitrile foam coating ensures oil resistance, breathability and excellent abrasion resistance.

Yarn: nylon
gauges: 18
Yarn colour: blue
Coating: Nitrile foam
Coating colour: blue



blister
Sizes: 7-8-9-10
Full box: 120 pa.



NEW
saving
package



07284DP 060
PU GLOVE
EN 388 3121X

The glove has excellent sensitivity and excellent resistance mechanically resistant to abrasion and tearing.

Yarn: polyester
gauges: 13
Yarn colour 060: black
Coating: polyurethane
Coating colour: black
Sizes: 8-9-10-11
Package: 12 pa. (not individually wrapped)
Full box: 240 pa.

060: black

050: white

080 grey: only on request



07284 060 / 050
PU GLOVE
EN 388 3121X

The glove has excellent sensitivity and excellent resistance mechanically resistant to abrasion and tearing.

Yarn: polyester **gauges:** 13
Yarn colour 060: black
Yarn colour 050: white
Coating: polyurethane
Colore spalmatura 060: black
Colore spalmatura 050: white



envelope without graphics
Sizes: 8-9-10-11 + 7 solo per colore black
Full box: 240 pa.

NEW

17284 060 / 050
PU GLOVE blister



blister
Sizes: 8-9-10
Colour: 050 white, 060 black
Full box: 60 pa.



07284 070
PU GLOVE
EN 388 3121X

The glove has excellent sensitivity and excellent resistance mechanically resistant to abrasion and tearing.

Yarn: polyester
gauges: 13
Yarn colour: red
Coating: polyurethane
Coating colour: grey



envelope without graphics
Sizes: 8-9-10-11
Full box: 240 pa.



TOP
QUALITY



07285 050 / 060
SOFT CATCH
EN 388 3141X

Continuous thread glove. Excellent abrasion resistance, good sensitivity. The glove is also breathable on the palm.

Yarn: poly / nylon
gauges: 13
Yarn colour 060: black
Yarn colour 050: white
Coating: polyurethane
Coating colour 060: black
Coating colour 050: white



poly bag
Sizes: 6-7-8-9-10-11
Full box: 120 pa.



TOP
QUALITY



07285 080
SOFT CATCH
EN 388 3141X

Continuous thread glove. Excellent abrasion resistance, good sensitivity. The glove is also breathable on the palm.

Yarn: poly / nylon
gauges: 13
Yarn colour: grey
Coating: polyurethane
Coating colour: light grey



poly bag
Sizes: 6-7-8-9-10-11
Full box: 120 pa.



18 gau-
ges



17281
ULTRA LIGHT CATCH
EN 388 2121A

Continuous thread glove that allows unparalleled sensitivity and lightness. The special knit facilitates breathability of the glove in both the back and palm. PU coating provides good levels of abrasion resistance.

Yarn: nylon
gauges: 18
Yarn colour: blue
Coating: polyurethane
Coating colour: black



blister
Sizes: 7-8-9-10
Full box: 60 pa.



EN 388:2016



1143X

07244
POLY COTTON
EN 388 1143X

Knitted glove, latex-impregnated palm. Excellent grip, ideal for construction and related work. Breathable back.

Yarn: polyester / cotton

Yarn colour: beige

Coating: latex

Coating colour: orange

Sizes: 8-9-10

Package: 12 pa.

Full box: 120 pa.

winter

07255

pag. 114



EN 388:2016



2131A

17364
HUNTER CATCH
EN 388 2131A

Glove with continuous thread camouflage knit, coated with knurled latex for excellent grip.

Yarn: polyester

gauges: 13

Yarn colour: camouflage

Coating: knurled latex

Coating colour: black



blister

Sizes: 7-8-9-10-11

Full box: 60 pa.



EN 388:2016



3132X

17366
RED SKIN CATCH
EN 388 3132X

Knurled latex coated glove that provides excellent grip.

Yarn: polyester

gauges: 13

Yarn colour: red

Coating: knurled latex

Coating colour: black



blister

Sizes: 8-9-10-11

Full box: 60 pa.



EN 388:2016



2132B

07289
GRIP HV CATCH
EN 388 2132B

Continuous thread glove with a latex foam coated palm that provides the glove with excellent grip. Thanks to the nylon backing, the glove has excellent sensitivity, in high-visibility yellow.

Yarn: poly / nylon

gauges: 13

Yarn colour: yellow fluo

Coating: Latex foam

Coating colour: black



poly bag

Sizes: 7-8-9-10

Full box: 120 pa.



EN 388:2016



2242X

17289
GRIP HV CATCH blister



blister

Sizes: 7-9-10

Full box: 60 pa.



blister

Sizes: 7-9-10-11

Full box: 60 pa.

Yarn: polyester

gauges: 15

Yarn colour: yellow

First coating: smooth latex **Second coating:** Latex sand effect

Coating colour: yellow lime / blue



blister

Sizes: 8-9-10-11

Full box: 120 pa.

07245

pag. 114



Other winter latex gloves



07255

pag. 114



17365

pag. 114



07245

pag. 114



GLOVES FOR GARDENING



CHILD'S GLOVES

17320 BABY CATCH

Latex-coated knitted glove for excellent grip.

Yarn colour: green

gauges: 13

Coating: latex

Coating colour: grey



blister

Sizes: S (6/7 years) – L (8/10 years)

Full box: 60 pa.



17212 GARDEN CATCH

Latex-coated knitted glove for excellent grip.

Yarn colour: flower

gauges: 13

Coating: latex

Coating colour: "flower" with blue coating



blister

Sizes: only 7

Full box: 60 pa.



Other gardening gloves



07362 ORANGE DOTS CATCH

Pag. 97



17364 HUNTER CATCH

Pag. 100



07256 FROG CATCH

Pag. 100



17366 RED SKIN CATCH

Pag. 100



07284 PU GLOVE Black

Pag. 99



07140 LEATHER GLOVE

Pag. 109



07202 MICROFIBER AND KNIT GLOVE

Pag. 113

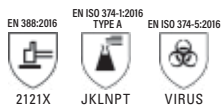

**07300
BLACK DEFENDER CAT. III**

Gloves made with rubber/neoprene with light cotton "flock" lining. Textured palm and fingers for a better grip, excellent mechanical resistance and protection against chemicals if used in the presence of slightly aggressive chemical products. Certified for food handling, Sanitized* treatment.

Outer composition: rubber/neoprene
Inside: light fleece
Colour: black



poly bag
Length: 320 mm (size XL)
Sizes: S-M-L-XL
Full box: 144 pa.

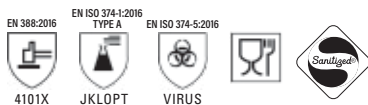

**07305
GREEN DEFENDER CAT. III**

Nitrile gloves with light, cotton "flock" lining and textured palm and fingers for a better grip. The glove offers excellent resistance to abrasion and its use is enhanced in the presence of hydrocarbons and chemical products thanks to the nitrile characteristics (pay attention to extreme situations). Certified for food handling, Sanitized* treatment.

Outer composition: nitrile
Inside: light fleece
Colour: green



poly bag
Length: 320 mm (size XL)
Sizes: S-M-L-XL
Full box: 144 pa.

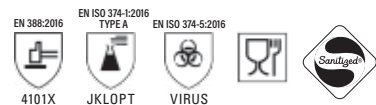

**07315
2 COLOR DEFENDER CAT. III**

Neoprene and latex rubber gloves with cotton flock lining and textured palm and fingers for a better grip. Gloves with low mechanical resistance but with good chemical protection against a large number of caustic substances. Certified for food handling, Sanitized* treatment.

Outer composition: neoprene and latex
Inside: light fleece
Colour: blue / yellow



poly bag
Length: 320 mm (size XL)
Sizes: S-M-L-XL
Full box: 144 pa.





TOP QUALITY

ISSALINE's TOP QUALITY range of impregnated nitrile gloves has been developed with a high degree of attention to product quality. Our aim is to offer an excellent and satisfactory solution to the most demanding users, who are not afraid to compare with any of the high-end alternatives on the market.

We have also paid close attention to the shape and design of our gloves to ensure maximum comfort during prolonged use. Our gloves are designed to fit your hands perfectly and offer excellent tactile sensitivity without compromising durability or protection.

The ISSALINE range of nitrile impregnated gloves is a superior product, carefully designed to meet the needs of the most demanding users without fearing comparison with other alternatives on the market.

We are confident that our gloves offer optimal durability, protection, and comfort at a competitive price.



TOP QUALITY

EN 388:2016



4221X

07260T NITRILE TOP

EN 388 4221X

TOP quality NITRILE gloves with canvas/cotton shell, safety cuff and ventilated back. Sanitized* treatment.

Support: canvas / cotton

Support colour: white

Coating: Nitrile

Coating colour: blue

Sizes: 9-10

Package: 12 pa.

Full box: 120 pa.



TOP QUALITY

EN 388:2016



4221X

07270T NITRILE TOP

EN 388 4221X

TOP quality NITRILE gloves with canvas/cotton shell and knitted cuff. Ventilated back.

Support: canvas / cotton

Support colour: white

Coating: Nitrile

Coating colour: blue

Sizes: 9-10

Package: 12 pa.

Full box: 120 pa.



TOP QUALITY

EN 388:2016



4221X

07280T NITRILE TOP

EN 388 4221X

TOP quality NITRILE gloves with canvas/cotton shell and safety cuff. Completely covered back. Sanitized* treatment.

Support: canvas / cotton

Support colour: white

Coating: Nitrile

Coating colour: blue

Sizes: 8-10

Package: 12 pa.

Full box: 120 pa.



EN 388:2016



2111A

07265 KNIT GLOVES

EN 388 2111A

NITRILE knitted glove with knitted cuff. Ventilated back.

Support: cotton

Support colour: white

Coating: Nitrile

Coating colour: yellow

Sizes: 7-8-9-10

Package: 12 pa.

Full box: 120 pa.



EN 388:2016



3111B

**07280
CANVAS GLOVES**

EN 388 3111B

TOP quality NITRILE gloves with canvas/cotton shell and safety cuff. Completely covered back.

Support: canvas / cotton

Support colour: white

Coating: Nitrile

Coating colour: blue

Sizes: 9-10

Package: 12 pa.

Full box: 120 pa.



EN 388:2016



4111B

**07260
CANVAS GLOVES**

EN 388 4111B

TOP quality NITRILE gloves with canvas/cotton shell and safety cuff. Ventilated back.

Support: canvas / cotton

Support colour: white

Coating: Nitrile

Coating colour: blue

Sizes: 9-10

Package: 12 pa.

Full box: 120 pa.



EN 388:2016



4111B

**07270
KNIT FABRIC GLOVES**

EN 388 4111B

NITRILE knitted glove with knitted cuff. Ventilated back.

Support: cotton

Support colour: white

Coating: Nitrile

Coating colour: blue

Sizes: 9-10

Package: 12 pa.

Full box: 120 pa.



EN 388:2016



4211B

**07275
KNIT FABRIC GLOVES**

EN 388 4211B

Knitted gloves with cuffs FULLY COATED WITH NITRILE.

Support: cotton

Support colour: white

Coating: Nitrile

Coating colour: blue

Sizes: 8-9-10-11

Package: 12 pa.

Full box: 120 pa.



07225
GLOVE COATED WITH PVC
27 cm
EN 388 4121X

Glove with PVC impregnated cotton jersey support.
Support: maglia di cotton
Support colour: white
Coating: PVC
Coating colour: red
Total length cm: 27
Sizes: 10
Full box: 60 pa.



07230
GLOVE COATED WITH PVC
35 cm
EN 388 4121X

Glove with PVC impregnated cotton jersey support.
Support: maglia di cotton
Support colour: white
Coating: PVC
Coating colour: red
Total length cm: 35
Sizes: 10
Full box: 60 pa.



07227
GLOVE COATED WITH PVC
42 cm
EN 388 4121X

Glove with PVC impregnated cotton jersey support.
Support: maglia di cotton
Support colour: white
Coating: PVC
Coating colour: red
Total length cm: 45
Sizes: 10
Full box: 60 pa.



07208
POLYESTER GLOVES WITH PVC
DOTTING
EN 388 4121X

Glove made with spunbonded 100% polyester yarn.
Yarn: polyester
Yarn colour: white
Dotted: PVC
PVC dotted palm colour: blue
Sizes: 6-7-8-9-10
Package: 12 pa.
Full box: 240 pa.



07215
LIGHTWEIGHT COTTON GLOVES
CE CAT. I - EN 420:2003+A1:2009

Knitted gloves in lightweight interlock cotton, fineness 18.
Yarn: light cotton interlock
gauges: 18
Yarn colour: white natural
Sizes: small 6-7^{1/2} - large 8-9^{1/2}
Package: 10 pa.
Full box: 500 pa.



07218
GKNITTED COTTON GLOVES
CE CAT. I - EN 420:2003+A1:2009

Gloves made with spunbonded cotton thread, without seams, quantlet cuffs, fineness 10.
Yarn: cotton
gauges: 10
Yarn colour: white natural
Sizes: small 6-7^{1/2} - large 8-9^{1/2}
Package: 10 pa.
Full box: 500 pa.

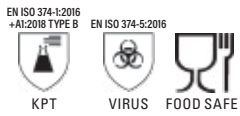
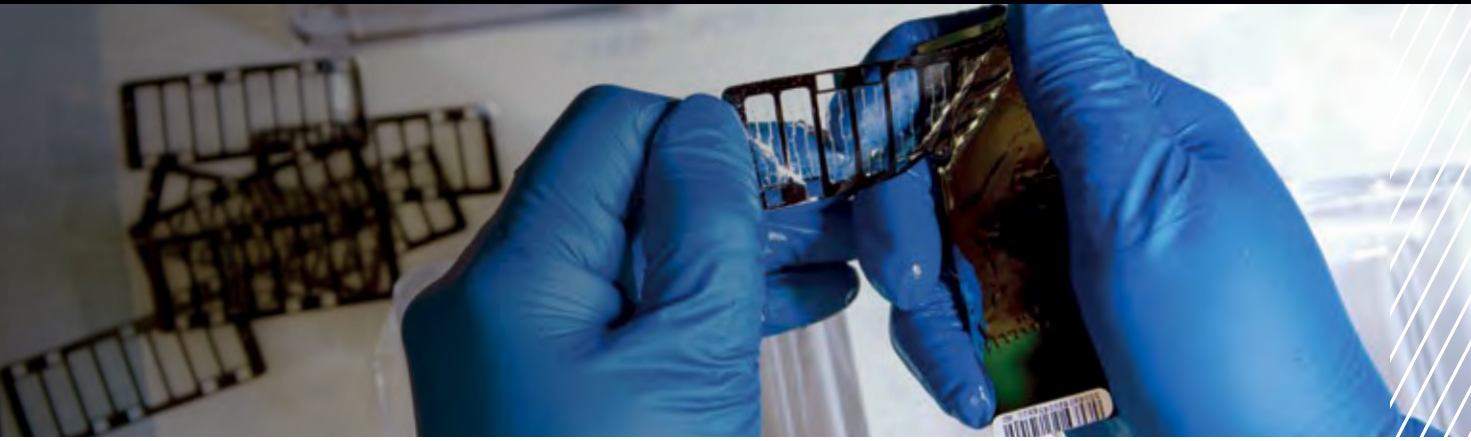

**07253
DISPOSABLE NITRILE GLOVES POWDER-FREE**

CE CAT. III
EN ISO 21420:2020
EN ISO 374-1:2016+A1:2018/TYPE B
EN ISO 374-5:2016
EN ISO 374-4:2019
AQL 1,5

Disposable ambidextrous nitrile gloves without powder. Excellent resistance to oil and petrol. The best alternative for users allergic to latex proteins. 100 pcs. Hanging dispensers.

Applications: logistics, chemistry, mechanical maintenance, assembly, hospital cleaning, food industry.

Composition: nitrile
Finger thickness: 0.10 +/- 0.03 mm
Colour: blue
Sizes: S/7 - M/8 - L/9 - XL/10
Hanging dispenser box: 100 pz.
Full box: 10 box.

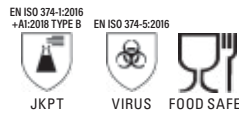

**07252N
DISPOSABLE NITRILE GLOVES POWDER-FREE**

CE CAT. III
EN ISO 21420:2020
EN ISO 374-1:2016+A1:2018/TYPE B
EN ISO 374-5:2016
EN ISO 374-4:2019
AQL 1,5

Ambidextrous powder-free nitrile disposable glove. Excellent resistance in the presence of oils and petrol. Best alternative for users allergic to latex proteins.

Applications: logistics, chemistry, mechanical maintenance, assembly, hospital cleaning, food industry.

Composition: nitrile
Thickness: 0,11 mm (4,5 mil)
Colour: black
Sizes: S/7 - M/8 - L/9 - XL/10
Hanging dispenser box: 100 pz.
Full box: 10 box.

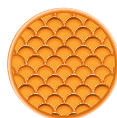

**NEW STANDARDS
FOR GRIP**

Grippaz® is a range of semi-disposable gloves that has revolutionised the use of gloves in industry and automotive. Made from a special formula of NBR (Nitrile Rubber), it provides an excellent protective barrier against many chemicals, oils, grease, blood pathogens and viruses.

The patented herringbone grip has been independently tested and approved by the renowned British laboratory SATRA, certifying superior grip compared to other disposable gloves of the same thickness.

For more information see the Grippaz pages.



246BK
Length: 240 mm



246OR
Length: 240 mm



306DB
Length: 300 mm



TOP QUALITY



17131 TOP LEATHER GLOVE

EN 388 4134X

Grain leather gloves with Top crust back. Reinforced thumb and Issa bordering. The glove is made with selected high quality leathers.

Composition: high quality leathers.

Colour: white, yellow reinforcement



blister 1 pa.

Sizes: 9-10

Package: 12 pa.

Full box: 60 pa.

NB: given the particular quality of the leather, these gloves are not always available.

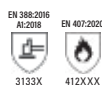

TOP SELLER

07131 COWHIDE LEATHER GLOVES

EN 388 3133X - EN 407 412XXX

Gloves with full grain leather palms, split leather back, hemmed at the bottom with elastic back.

Composition: full grain leather palms, split leather back

Colour: 050 white

Sizes: 8-9-10-11

Full box: 120 pa.

17131 COWHIDE LEATHER GLOVES

EN 388 3133X - EN 407 412XXX

Gloves with full grain leather palms, split leather back, hemmed at the bottom with elastic back.

Composition: full grain leather palms, split leather back

Colour: 050 white



blister 1 pa.

Sizes: 8-9-10-11

Full box: 60 pa.



PRICE



07129 COWHIDE LEATHER GLOVES

EN 388 2121X - EN 407 412XXX

Glove with palm in cowhide grain leather and split leather back. Elastic back.

Composition: full grain leather palms, split leather back

Colour: 050 white

Sizes: 8-9-10-11

Full box: 120 pa.

ISSALINE
BY PIP

TOP QUALITY 17131T 17140T

The TOP QUALITY line distinguishes itself through the use of premium leathers that are not commonly found in work gloves.

These products were developed to cater to the demands of customers seeking high-end items comparable to 'national gloves'. As the leather used has gained popularity, it may not always be readily available.

We recommend verifying its availability at our warehouse before finalizing any orders for your customers.

Additionally, the gloves are packaged in smaller quantities than usual to avoid excessive compression during shipping and maintain their initial softness.



TOP QUALITY



4134X

17140T TOP LEATHER GLOVE

EN 388 4134X

glove with thumb reinforcement and Issa border. The glove uses only selected and high quality leathers.

Composition: high quality leathers.

Colour: white, yellow reinforcement



blister 1 pa.

Sizes: 8-9-10-11**Package:** 12 pa.**Full box:** 60 pa.

NB: given the particular quality of the leather, these gloves are not always available

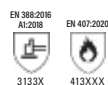

3133X



413XXX

TOP SELLER

07140 COWHIDE GRAIN LEATHER GLOVES

EN 388 3133X - EN 407 413XXX

Glove with palm and back made of cowhide grain leather, hemmed. Elastic back.

Composition: full grain leather

Colour: 050 white

Sizes: 8-9-10-11**Full box:** 120 pa.

17140 COWHIDE GRAIN LEATHER GLOVES

EN 388 3133X - EN 407 413XXX

Glove with palm and back made of cowhide grain leather, hemmed. Elastic back.

Composition: full grain leather

Colour: 050 white



blister 1 pa.

Sizes: 8-9-10-11**Full box:** 60 pa.

PRICE



2121X



412XXX

07139 COWHIDE GRAIN LEATHER GLOVES

EN 388 2121X - EN 407 412XXX

Glove with palm and back made of cowhide grain leather, hemmed. Elastic back.

Composition: full grain leather

Colour: 050 white

Sizes: 8-9-10-11**Full box:** 120 pa.



GLOVES ELECTRO-INSULATING EN 60903:2003 + AC2:2005 PPE Category III



DIELECTRIC GLOVES TYRON E N 60903:2003 + AC2:2005 – DPI III Category

Gloves against electrical risks from 2.500 to 40.000 volts.
For the specificity of use in high-risk situations, the gloves are subject to periodic checking and cannot be used when more than 6 months have elapsed since the end of the last analysis and in case of new ones, not yet used when the date of the latest analysis is no more than 12 months.

ART.	CLASS	VOLTS TEST	VOLTS USE	SIZE
07603N	00	2.500 Volts	500 Volts	8-9-10-11-12
07607N	0	5.000 Volts	1.000 Volts	8-9-10-11-12
07612N	1	10.000 Volts	7.500 Volts	8-9-10-11-12
07621N	2	20.000 Volts	17.000 Volts	8-9-10-11-12
07631N	3	30.000 Volts	26.500 Volts	9-10-11-12
07641N	4	40.000 Volts	36.000 Volts	9-10-11-12



EN 388:2016
A1:2018

EN 407:2004

4544XX 43324X

07290
GLOVES MADE WITH
ARAMID FABRICO

EN 388 4544XX - EN407 43324X

RESISTANT TO HIGH TEMPERATURES PPE
CATEGORY III

They resist contact heat for 15 seconds at a
temperature of 350° C.

Composition: aramid fabric

Colour: light yellow

Total length cm: 28

Size: 10

Package: 5 pa.

Full box: 60 pa.



EN 388:2016
A1:2018

EN 407:2004

4544XX 43324X

07291
GLOVES MADE WITH
ARAMID FABRIC

EN 388 4544XX - EN407 43324X

RESISTANT TO HIGH TEMPERATURES PPE
CATEGORY III

They resist contact heat for 15 seconds at a
temperature of 350° C.

Composition: aramid fabric

Colour: light yellow

Total length cm: 38

Size: 10

Package: 5 pa.

Full box: 60 pa.



250000xR0302
CHAINEX GLOVES

EN 1082-1

Single glove, reversible right left. Stainless steel mesh, 5
fingers, fitted with plastic strap (replaceable), or adjustable
fabric and buckle with press stud.

Length from 20.8 to 25 cm. fabric strap.

Sizes: x = 0-1-2-3-4-5 (6-7-8-9-10-11)

Full box: 1 pz.



EN 388:2016

EN 381-7:1999

3122XX CLASSE 2:24 m/s

07590
FORESTRY GLOVES
CHAINSAW CUT-RESISTANT

EN 420-2003 + A1:2009 CAT.: III

EN 388:2016 3122XX

EN 281-7:1999 CLASSE 2 : 24 m/s

**N.B. PROTECTION AND CERTIFICATION LEFT GLOVE
BACK ONLY.**

Cut-resistant forestry gloves for chainsaws.

N.B.: Protection and certification left glove back only. This
product has been manufactured in accordance with the
requirements of the EU Regulation 2016/425, for basic use,
according to EN 420:2003+A1:2009, general requirements, EN
388:2016, against mechanical risks and EN 381-7:1999 against
risks due to chain saw cutting, applicable to it in accordance
with certificate No. 18/0895/00/0161 de ATEX, Plaza Emilia
Sala No. 1, Aloy, Spain, notified body 0161.

Minimum saleable: 1 pa.

Sizes: 9-10-11

Full box: 5 pa.



**07138
COWHIDE GRAIN LEATHER GLOVES**

EN 388 4124X

Glove with palm and back made of full grain cowhide leather and crust leather cuff.

Composition: full-grain leather palm and back, split leather sleeve.

Colour: 050 white

Sizes: 9-10

Package: 10 pa.

Full box: 120 pa.



**07134
COWHIDE LEATHER GLOVES WITH
SPLIT LEATHER GLOVES**

EN 388 4124X

Palm made of split leather, back and cuff made of split leather.

Composition: full-grain leather palm, split leather back and sleeve

Colour: 050 white

Sizes: 9-10

Package: 10 pa.

Full box: 120 pa.



**07121
COWHIDE SPLIT LEATHER GLOVES**

EN 388 4133X - EN12477 tipo A EN407 413X4X

Glove made with superior cowhide split leather with heat-resistant treatment (THT). It withstands contact heat at a temperature of 100° C for 15 seconds. Seam protector, palm and cuff back lining.

Composition: cowhide split leather

Colour: red

Total length cm: 38

Size: 10

Package: 6 pa.

Full box: 60 pa.



seams
Kevlar™



**07121K
COWHIDE SPLIT LEATHER GLOVES
seams Kevlar®**

EN 388 4133X - EN12477 tipo A EN407 413X4X

Glove made with superior cowhide crust leather with heat-resistant treatment (THT). It withstands contact heat at a temperature of 100° C for 15 seconds. Split leather Kevlar seam protector, palm and cuff back lining.

Composition: cowhide split leather

Colour: red

Total length cm: 38

Size: 10

Package: 6 pa.

Full box: 60 pa.



**07112
COWHIDE SPLIT LEATHER GLOVES**

EN 388 3123X

Glove completely made with split leather.

Composition: split leather

Colour: 050 white natural

Cuff cm: 7

Sizes: 10

Full box: 60 pa.



**07117
GLOVE REINFORCED WITH
COWHIDE SPLIT LEATHER**

EN 388 2124X

Glove completely made with split leather.

Composition: split leather

Colour: 050 white natural

Cuff cm: 7

Sizes: 10

Full box: 60 pa.



ISSALINE
PIP



EN 388:2016
EN12477-tipo A
EN 407
3134X 413X4X

07127 COWHIDE SPLIT LEATHER GLOVES

EN 388 3134X - EN12477 tipo A EN407 413X4X

Glove completely made with split leather.

Composition: split leather

Colour: 050 white natural

Cuff cm: 15

Sizes: 10

Full box: 60 pa.



EN 388:2016
EN12477-tipo A
EN 407
3144X 414X4X

07122 GLOVE REINFORCED WITH COWHIDE SPLIT LEATHER

EN 388 3134X - EN12477 tipo A EN407 414X4X

Glove completely made with split leather.

Composition: split leather

Colour: 050 white natural

Cuff cm: 15

Sizes: 10

Full box: 60 pa.



EN 388:2016
4144X

07104 COWHIDEREINFORCED CANVAS GLOVES

EN 388 4144X

Glove with split leather palm, canvas back and cuff. Reinforced palm, thumb and forefinger.

Composition: split leather / canvas

Colour: White natural leather, green (reinforcement), white canvas

Cuff cm: 7,5

Sizes: 10

Package: 12 pa.

Full box: 60 pa.



17010 PIG LEATHER AND CANVAS GLOVES

CE CAT. I - EN 420:2003+A1:2009

Glove with pig crust leather palm, canvas back and cuff and elastic back.

Composition: leather and canvas

Colour: yellow leather, blue canvas with black and red stripes



blister 1 pa.

Sizes: 10

Full box: 60 pa.



EN 388:2016
2231X

07202 MICROFIBRE AND KNITTED FABRIC GLOVES

EN 388 2231X

Gloves with microfibre palms and ventilated back in stretch cotton jersey. Cuff with Velcro closure strap.

Composition: microfibre (50 % PU, 50 % nylon) / knitted 100% stretch cotton.

Materiale manichetta: elastan

Size colour: 7 green, 8 yellow, 9 blue, 10 red

Sizes: 7 green, 8 yellow, 9 blue, 10 red

Package: 12 pa.

Full box: 120 pa.



17365
WARM CATCH
EN 388 3131C - EN511 X2X

Gloves for low temperatures with shell made of "Terry cloth" spunbonded thread with latex foam coating that provides excellent grip.

Yarn: "Terry cloth"

gauges: 13

Yarn colour: orange

Coating: Latex foam

Coating colour: black



Sizes: 8-9-10

Full box: 60 pa.



07245
BISON CATCH
EN 388 2132X - EN511 041

Winter glove with double latex coating and bonded anticold liner (inner "terry cloth" / outer polyester). Inner coating protects and makes the glove waterproof up to the wrist, while the outer "sandy" latex finishing increases even more the latex typical grip.

Yarn: "Terry cloth" / polyester

Yarn colour: blue

Coating: Smooth latex + sanded latex

Coating colour: blue / black



Sizes: 8-9-10

Full box: 60 pa.



07203W
LONG COMFORT WINTER
CE CAT. I - EN 420:2003+A1:2009

High Tech glove with soft Clarino synthetic leather palm. Nylon Spandex back, flexible neoprene panel for protecting the knuckles. Washable at 30° C. With THINSULATE® lining against cold. Use: DIY, gardening, mechanics and for cold weather sports.

Fields of application: DIY, gardening, mechanics and low temperature sports.

Yarn: nylon spandex

Yarn colour: yellow

Palm: Clarino synthetic leather

Colour: yellow / black



Sizes: M-L-XL

Minimum order: 5 pa.

Full box: 10 pa.



07255
POLY/COTTON PLUSH GLOVES COATED WITH LATEX
CE CAT. I - EN 420:2003+A1:2009

Gloves made with knitted polyester/cotton fabric, palms coated with latex, ventilated back, winter plush lining.

Yarn: polyester cotton

Yarn colour: blue

Coating: Latex foam

Coating colour: black

Sizes: 8-9-10

Package: 12 pa.

Full box: 120 pa.



07165
PADDED COWHIDE LEATHER GLOVES
CE CAT. I - EN 420:2003+A1:2009

Glove with full grain leather palm, hemmed at the bottom with elastic back, padded with synthetic fur.

Composition: cow grain leather / padded synthetic fur

Colour: 050 white

Sizes: 10

Package: 5 pa.

Full box: 60 pa.



07155
LINED COWHIDE LEATHER GLOVES
CE CAT. I - EN 420:2003+A1:2009

Glove with full grain leather palm and back, hemmed at the bottom, flannel lining and elastic back.

Composition: full-grain cowhide leather / flannel-lined

Colour: 050 white

Sizes: 10

Package: 10 pa.

Full box: 60 pa.



WORK & SPORT

ISSALINE's Work&Sport glove family is a game-changer in the industry, bringing together cutting-edge materials and ergonomic designs typically reserved for sports gear.

These gloves are crafted to deliver top-notch performance whether you're at work or at play, offering a versatile and effective solution.

Carefully chosen materials ensure durability and strength without sacrificing comfort, thanks to high-tech synthetic fibres that provide breathability and thermal insulation for various environmental conditions.

The ergonomic design of the Work&Sport gloves guarantees a snug fit and enhanced hand sensitivity, making them perfect for workers who require precision in their tasks, like craftsmen or professionals, as well as athletes seeking a protective and comfortable accessory for outdoor activities.



07203W LONG COMFORT WINTER

CE CAT. I - EN 420:2003+AI:2009

High Tech glove with soft Clarino synthetic leather palm. Nylon Spandex back, flexible neoprene panel for protecting the knuckles. Washable at 30° C. With THINSULATE® lining against cold. Use: DIY, gardening, mechanics and for cold weather sports.

Fields of application: DIY, gardening, mechanics and low temperature sports.

Yarn: nylon spandex

Yarn colour: yellow

Palm: Clarino synthetic leather

Colour: yellow / black



blister

Sizes: M-L-XL

Minimum order: 5 pa.

Full box: 10 pa.



EN 388:2016



2231X

07203 LONG COMFORT

EN 388 2231X

High Tech glove with soft Clarino synthetic leather palm. Spandex nylon backhand, flexible neoprene panel to protect knuckles. Adjustable Velcro fastener. Washable at 30° C.

Fields of application: DIY, gardening, mechanics and low temperature sports.

Yarn: nylon spandex

Yarn colour: red

Palm: Clarino synthetic leather

Colour: red / black



blister

Sizes: M-L-XL-XXL

Minimum order: 5 pa.

Full box: 10 pa.



EN 388:2016



2231X

07204 SOFT GRIP

EN 388 2231X

High Tech glove with Clarino synthetic leather palm. Silicone-bound palm for excellent grip, shock-absorbing neoprene padding to protect knuckles. Adjustable Velcro fastener.

Fields of application: construction, plumbing, sport and leisure.

Yarn: nylon spandex

Yarn colour: orange

Palm: Clarino synthetic leather

Colour: red / black



blister

Sizes: M-L-XL-XXL

Minimum order: 5 pa.

Full box: 10 pa.



EN 388:2016



2231X

07206 ISSA SHOCK

EN 388 2231X

Glove with synthetic leather palm. Anti-slip sport grip on palm, shock-absorbent and anti-vibration gel padding on palm. Adjustable Velcro fastener.

Fields of application: electro-tool use with vibration, need for dry grip, mountain biking and other sports.

Yarn colour: black

Palm: synthetic leather

Colour: black



blister

Sizes: S-M-L-XL-XXL

Minimum order: 5 pa.

Full box: 10 pa.



**07323
RACE**

CE CAT. I - EN 420:2003+A1:2009

High Tech glove of sporting derivation, made of Clarino synthetic leather but enriched with rubber reinforcements, absorbent gel inserts, anti-slip silicone applications. Gussets are applied to the fingers to facilitate phalanx articulation. Only by wearing it can you understand the complexity and technology of this glove. Adjustable Velcro fastener.

Fields of application: DIY and leisure.

Yarn colour: red

Palm: Clarino synthetic leather

Colour: palm brown, back red



blister

Sizes: M-L-XL-XXL

Minimum order: 5 pa.

Full box: 10 pa.



**07325
ARMY**

CE CAT. I - EN 420:2003+A1:2009

High Tech glove with palm in soft Clarino synthetic leather. Camouflage back with knuckle protector insert. Practical Velcro fastener. Silicone anti-slip reinforcements on fingers (except index finger).

Fields of application: despite having a military look, it is versatile and can be used in any DIY, gardening and of course hunting/fishing work. Adjustable Velcro fastener.

Yarn colour: camouflage

Palm: Clarino synthetic leather

Colour: camouflage



blister

Sizes: M-L-XL-XXL

Minimum order: 5 pa.

Full box: 10 pa.



**07326
STREET GLOVE**

CE CAT. I - EN 420:2003+A1:2009

High Tech glove with palm made of soft Clarino synthetic leather. High-visibility stretch nylon back. Reflective band. Convenient Velcro closure.

Fields of application: automobiles, scooters and in general wherever a large sensitivity is required and it is appreciated that the glove is easily visible both at night and during the day. Please note: the glove does not have enough surface area to be certified according to current regulations in terms of high visibility.

Yarn colour: orange e yellow lime fluo

Palm: Clarino synthetic leather

Colour: orange and yellow lime fluo



blister

Sizes: M-L-XL-XXL

Minimum order: 5 pa.

Full box: 10 pa.

G-Tek[®]
BY **PIP**

Hand
protection



SUSTAINABILITY AT PIP

SUSTAINABILITY IS NOT A TREND FOR US, BUT A PROCESS

As a company with global economic relations, we are committed to complying with applicable law, observing social and ecological standards and acting sustainably along our global value chain.

Responsibility for people and the environment is systematically implemented, continuously improved and is deeply anchored in our core processes and main products.

BETTER  WORLD



GREEN HEART®

GREEN HEART FOR A BETTER WORLD

In the products sector, we fulfil our responsibility and meet the demand of partners, end customers and retailers for environmentally friendly articles by developing sustainable products under the "Green Heart" label



HIGH STANDARDS

FOR A FAIR & SUSTAINABLE WORLD

We are achieving our mutual goal of a fair and sustainable world with the continuous improvement of our supply chain. We only work with partners who fulfil the environmental, chemical, health and safety related, and the social requirements. These requirements apply even if they are stricter than or contradict local standards.



G-Tek®
BY PIP

GREEN HEART®



PolyKor®

HIGH-TECHNOLOGY CUT RESISTANT FIBERS & YARNS



PolyKor®

PROTECTION. PERFORMANCE. VALUE.

PolyKor® engineered yarns optimize performance, function and protection using proprietary blends of select fibers to exceed industry standards. The ultimate objective is an affordable array of cut resistant gloves for practically every application.



PolyKor®
X7™ TECHNOLOGY

HIGH DEXTERITY. MAXIMUM CUT RESISTANCE.

X7™ technology is the latest in engineered yarn development. This super lightweight reinforced yarn provides very high cut resistance and durability by way of proprietary fibers.



PolyKor®
XCRYSTAL™

STRONGEST. TOUGHEST. HARDEST.

Crystal™ technology represents the latest in PolyKor® engineered yarns that are combined with naturally hardened crystallized minerals. The result is a super tough, durable, cut resistant fiber that is at the peak of performance.



A complete line of coatings

A COMPLETE LINE OF COATINGS UNMATCHED
IN SELECTION AND PERFORMANCE

NEOFOAM®

SECURE HANDLING OF LIGHT TO HEAVY PARTS OR ITEMS

Proprietary coating only available on G-Tek® brand gloves. NeoFoam® is a highly flexible coating that provides wearers with a high degree of grip, hand dexterity and comfort. It is versatile, hardworking, resistant to light oils and touchscreen compatible with most devices. The optimal choice for numerous handling applications.

- ▶ **MICROSURFACE**
- ▶ **FOAM**

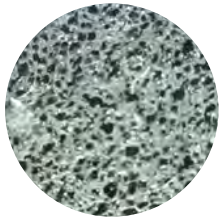

▶ **MICROSURFACE**

Coating surface infused with thousands of tiny suction cup pockets. When pressed into contact with a wet or oily surface, they create a vacuum effect that disperses fluids away significantly improving grip.

- > good grip in dry, wet or oily conditions

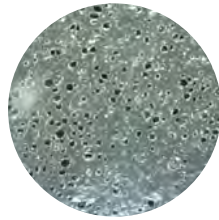

▶ **FOAM**

Foam coating cell structure is designed to channel fluids away from the surface of the object helping improve grip in oily conditions. Oily grip effectiveness varies with density of cells.

- > secure grip in dry conditions
- > fair grip in slightly oil or wet conditions



▶ **FLAT / SMOOTH**

Flat/Smooth coatings provide the wearer with a secure dry grip. Liquids will not absorb into the coating, keeping hands dry and clean.

- > secure, tacky grip for dry surfaces

NITRILE

TOUGH COATING FOR HEAVY-DUTY JOBS

Nitrile is a synthetic rubber compound that offers excellent puncture, tear and abrasion resistance. Nitrile is also known for its resistance to hydrocarbon-based oils or solvents. Nitrile coated gloves are the first choice for industrial jobs which require handling of oily parts. Nitrile is durable and helps to maximize protection

- ▶ **MICROSURFACE**
- ▶ **FOAM**
- ▶ **FLAT / SMOOTH**

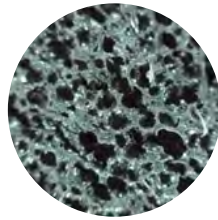

▶ **MICROFOAM**

MICROFOAM (micro-foam) is a special formulation that allows gloves to be covered with a thin layer of nitrile for better improved grip, dexterity, comfort and breathability.

- > Controlled grip on dry dry and slightly oily surfaces
- > premium comfort and flexibility quality



▶ **CRINKLE**

Crinkle coatings have creases or wrinkles on the surface of the coating that are designed to channel fluids away and allow better contact on dry or wet surfaces.

- > secure grip in dry or wet conditions



▶ **FLAT/TEXTURED**

Flat/Textured PU takes on the surface properties of the glove liner which results in the thin, conformable deposit of coating material. The flat, textured nature of this coating is unique to Polyurethane (PU) coated gloves.

- > tactile grip in dry and in slightly oily conditions



LATEX

TOUGH JOBS — DRY OR OILY-WET

Latex is a natural rubber that is flexible, tough and durable, delivering a high degree of resistance to snagging, puncture and abrasion. Latex is waterresistant as well as resistant to protein-based oils. Latex is not recommended for jobs that involve contact with hydrocarbon-based oils or solvents.

- ▶ CRINKLE
- ▶ MICROSURFACE

POLYURETHANE

IDEAL FOR PRECISION HANDLING AND LIGHT TO MEDIUM DUTY JOBS

Polyurethane (PU) is a tough, proven material that offers good tactile sensitivity by way of its thin material deposit. It conforms intimately over multiple glove liners to provide flexibility, dexterity and tactile sensitivity. PU coated gloves are amongst the most commonly used because they are versatile and provide excellent value. Newer, water-based PU coatings offer improved flexibility and less environmental lifecycle impact.

- ▶ FLAT/TEXTURED

NEW

Serie X-Treme™

R-ESPIR COATING TECHNOLOGY™

COMFORTABLE & BREATHABLE

Our gloves are designed to be comfortable and breathable. This increased breathability combined with the Sanitized® hygienic function, prolongs freshness and protection and comfort, even when used intensively and repeatedly. It has been designed and developed to improve comfort by by eliminating the build-up of heat inside the glove, guaranteeing 360° breathability for the hand.

- ▶ FOAM

COATING	GRIP	1	2	Fair	Good	Secure	Fair	Good	Secure	Fair	Good	Secure	None	Limitata	Good	None	Fair	Good	Low	Medium	High	None	Minimal	High	
		LAYERS	DRY GRIP	SLIGHTLY WET GRIP	OILY SURFACES GRIP	TOUCHSCREEN*	BREATHABILITY	DURABILITY	LIQUID RESISTANCE																
NeoFoam®	Foam	•				•	•			•					•		•			•			•		
	Microsurface	•				•	•				•				•	•					•			•	
Nitrile	Microsurface		•		•		•				•			•		•					•			•	
	Microsurface	•			•		•				•			•		•				•				•	
	Foam	•			•				•					•			•				•		•		
	Flat/Smooth	•				•								•		•				•				•	
X-Treme	Nitrile Foam	•			•		•				•			•			•				•		•		
LATEX	Microsurface		•			•		•			•		•			•					•			•	
	Microsurface	•				•		•			•		•			•					•			•	
	Crinkle	•				•		•			•		•			•					•			•	
Polyurethane	Flat / Textured	•			•		•			•				•	•				•					•	



Understanding EN performance markings

PIP GLOVES ARE TESTED TO ANSI AND EN STANDARDS

EN 388:2016

Mechanical Risks

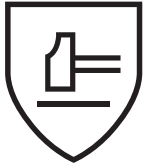

A	B	C	D	E	F
Abrasion (0-4)	Cut (0-5)	Tear (0-4)	Puncture (0-4)	Impact (P)	Impact (I)

NEWTON LEVEL

Newton	Level
≥ 30	F
≥ 20	E
≥ 15	D
≥ 10	C
≥ 5	B
≥ 2	A

HIGH



LOW



Protection level	1	2	3	4	5	
A: Abrasion Resistance (No. of Cycles)	100	500	2000	8000	N.D.	
B: Blade Cut Coupe Test (Index)	1,2	2,5	5	10	20	
C: Tear Resistance (Force in Newtons)	10	25	50	75	N.D.	
D: Leakage resistance (force in Newtons)	20	60	100	150	N.D.	
	A	B	C	D	E	F
E: ISO Cut (Force in Newtons)	≥ 2	≥ 5	≥ 10	≥ 15	≥ 22	≥ 30
F: Impact (force in Newtons)	Pass	Fail				

EN 407:2022

Protection Against Thermal Hazards



Gloves tested for fire



Gloves not tested for fire

A general standard designed to be used for any glove which is to be designed and sold as providing protection against thermal hazards. The standard includes six thermal tests: burning behaviour, contact heat, convective heat, radiant heat, small and large splashes of molten metal plus reference to EN 388:2016 and EN 420:2003 for mechanical and general performance requirements.

A	B	C	D	E	F
Burning Behaviour (0-4)	Contact Heat (0-4)	Convective Heat (0-4)	Radiant Heat (0-4)	Splashes of Molten Metal (0-4)	High amount of Molten Metal (0-4)

	Performance Levels	1	2	3	4	
A	Burning behaviour	After flare time	≤ 20 s	≤ 10 s	≤ 3 s	≤ 1 s
		After glow time	Not reqd.	≤ 120 s	≤ 25 s	≤ 5 s
B	Contact heat	Contact temperature	100 °C	250 °C	350 °C	500 °C
		Threshold time	≥ 15 s	≥ 15 s	≥ 15 s	≥ 15 s
C	Convection heat	Heat transfer delay	≥ 4 s	≥ 7 s	≥ 10 s	≥ 18 s
D	Radiant heat	Heat transfer delay	≥ 7 s	≥ 20 s	≥ 50 s	≥ 95 s
E	Small drops of melted	Heat transfer delay	≥ 10	≥ 15	≥ 25	≥ 35
F	Large quantity of molten metal	Heat transfer delay	30 g	60 g	120 g	200 g

X in this test denotes NOT TESTED

EN 511:2006

Protective Gloves Against Et CNo5ld



The pictogram (to the left) will be accompanied by a 3-character code:

A - Resistance to convective cold = based on the glove's insulating properties, this measures the transfer of cold through convection (performance levels 0 to 4, with 4 being the highest).

B - Resistance to contact cold = based on the glove's thermal capacity when in contact with a cold object (performance levels 0 to 4, with 4 being the highest).

C - Permeability to water = Glove's capacity to resist water penetration (0 = Fail; 1 = Pass).

0 = Water penetration after 5 minutes (replaces the previous standard of 30 min).

1 = No water penetration after 5 minutes (replaces the previous standard of 30min).

X = Not Tested

A B C

Convection cold (0-4)
Contact cold (0-4)
Water impermeability (0 or 1)

Explanation on levels of performance

(Table relevant in ambient air temperature at a wind speed below 0,5 m/s.)

Performance Level	Minimum Using Conditions (°C) Low Activity	Minimum Using Conditions (°C) Medium Activity	Minimum Using Conditions (°C) High Activity
1	-	10	-15
2	-	0	-30
3	8	-15	-
4	-10	-30	-

G-Tek[®]
BY **PIP**

HAND PROTECTION

**PRECISION WORK
CUTTING RESISTANCE**



G-Tek
BY PIP

G-TEK
SAFETY GLOVES



"INNOVATION AT THE SERVICE OF THE ENVIRONMENT"



GREEN HEART®

1st Range of gloves made from recycled plastic bottles

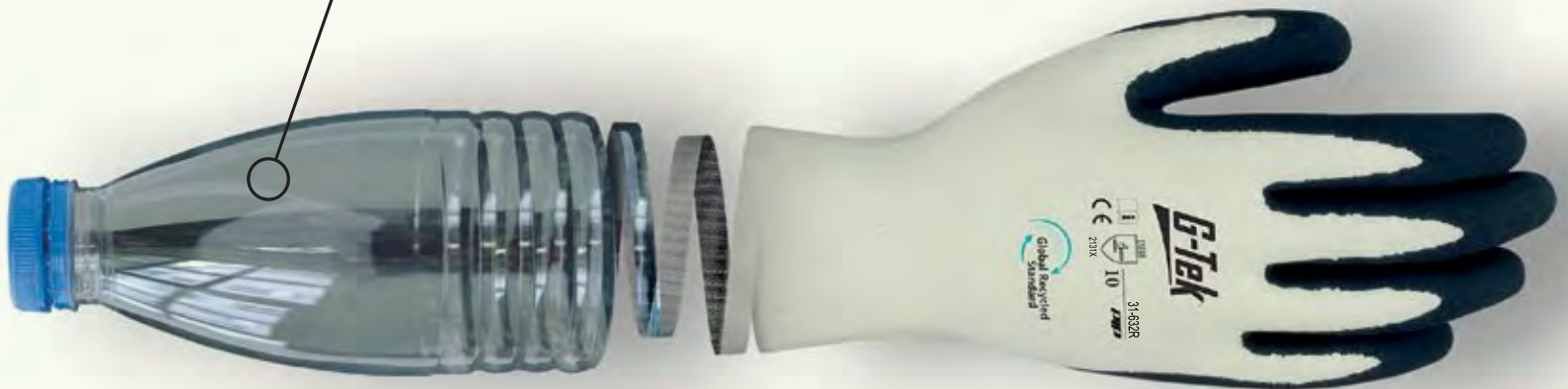

Certified by USB Registration no: USB 002629

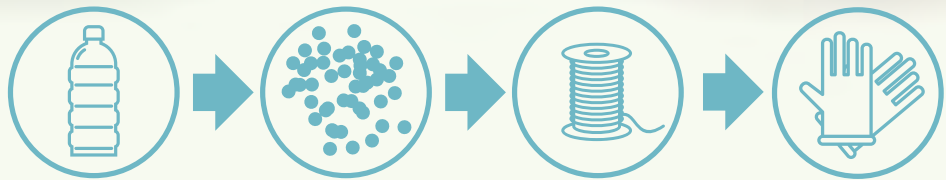

NEW

GREEN HEART® DRY ENVIRONMENT

GREEN HEART® OILY OR WET ENVIRONMENT

NEW

GREEN HEART® OILY OR WET ENVIRONMENT



31-131R-EN

Excellent abrasion resistance extending glove life, each pair is made from PET plastic bottles and reduces 33,33 g of CO₂ emissions per pair.

Sizes: 6-7-8-9-10-11-12



31-330R-ET (31-330R-EN only on request)

Nitrile Foam coating offers a high abrasion resistance, each pair is made from P.E.T. plastic bottles and reduces 39,16 g of CO₂ emissions per pair.

Sizes: 7-8-9-10-11 (6-12 on request)



31-632R-EN

Offers superior grip in dry and wet conditions, each pair is made from P.E.T. plastic bottles and reduces 39,16 g of CO₂ emissions per pair.

Sizes: 6-7-8-9-10-11-12

STYLE	GAUGE	EN388	COATING	COATING COVERAGE	LINER	GREEN HEART	SIZE	PACKAGING
31-131R-EN	13	3131X	PU	Palm & Fingers	Recycled plastic	GRS	6 - 12	bundle 12 / 120
31-330R-ET	13	4121X	Nitrile Foam	Palm & Fingers	Recycled plastic	GRS	7 - 11	blister 12 / 120
31-632R-EN	13	2131X	LATEX microsurface	Palm & Fingers	Recycled plastic	GRS	6 - 12	bundle 12 / 120



NEW

GREEN HEART™ WET OR OILY ENVIRONMENT

DB
B



41-8150R-EN

Excellent thermal insulation, superior grip and high comfort, rapidly evaporates moisture from the skin, each pair is made from P.E.T. plastic bottles and reduces 80,83g of CO₂ emissions per pair.
Sizes: 6-7-8-9-10-11 (12 on request)

GREEN HEART™ OILY ENVIRONMENT



31-5130R-ET

ESD. Nitrile Foam coating offers a high abrasion resistance, each pair is made from P.E.T. plastic bottles and reduces 36,75g of CO₂ emissions per pair.
Sizes: 6-7-8-9-10-11 (12 ON REQUEST)

GREEN HEART™ OILY ENVIRONMENT



31-5131R-ET

Nitrile Foam coating with dots offers a high abrasion resistance, each pair is made from P.E.T. plastic bottles and reduces 36,75g of CO₂ emissions per pair.
Sizes: 6-7-8-9-10-11-12

NEW

GREEN HEART™ DRY ENVIRONMENT



31-3150ER-EN

Excellent abrasion resistance that extends the life of the glove; each pair is made from PET plastic bottles and reduces CO₂ emissions by 26,25 g per pair.
Sizes: 6-7-8-9-10-11 (12 on request)

NEW

GREEN HEART™ OILY & DRY ENVIRONMENT

DB
C



16-1835R-EN

Excellent abrasion resistance and grip on dry or oily surfaces, high tactile sensitivity and dexterity, each pair is made from PET plastic bottles and reduces 29,16 g of CO₂ emissions per pair.
Sizes: 6-7-8-9-10-11-12

STYLE	GAUGE	EN388	EN407	EN511	COATING	COATING COVERAGE	LINER	GREEN HEART	SIZE	PACKAGING
41-8150R-EN	10	2X42B		X2X	LATEX microsurface	Palm & Fingers	Recycled plastic	GRS	6 - 11	bundle 6 / 72
31-5130R-ET	15	4121A	X1XXXX		Nitrile Foam	Palm & Fingers	Recycled plastic	GRS	6 - 11	blister 12 / 120
31-5131R-ET	15	4121A	X1XXXX		Nitrile Foam with dots	Palm & Fingers	Recycled plastic	GRS	6 - 12	bundle 12 / 120
31-3150ER-EN	13	3131X			PU	Palm & Fingers	Recycled plastic	GRS	6 - 11	bundle 12 / 120
16-1835R-EN	18	4X42C	X1XXXX		Nitrile Foam	Palm & Fingers	Recycled plastic	Yes	6 - 12	bundle 6 / 72



G-Tek
BY PIP

G-TEK
CUT-RESISTANT GLOVES

CUT-RESISTANT

B

DRY ENVIRONMENT



16-319-EN

18 gauge liner offers excellent dexterity, good tactile sensitivity, comfort and breathability.

Sizes: 7-8-9-10-11 (6-12 on request)

B

OILY ENVIRONMENT



16-323-EN

Nitrile Foam coating offers a good resistance to light oils and abrasion, high dexterity and tactility, excellent durability, contact heat resistant up to 100°C.

Sizes: 7-8-9-10-11 (6-12 on request)

C

OILY & DRY ENVIRONMENT



16-368-EN

18 gauge liner. ESD. Without DMF. High tactile sensitivity and dexterity, NeoFoam® coating offering good breathability for increased comfort.

Sizes: 7-8-9-10-11

C

DRY ENVIRONMENT



16-533-EN

Excellent abrasion resistance extending glove life, cut resistance C. Oeko-Tex-standard approved.

Sizes: 7-8-9-10-11 (6-12 on request)

C

DRY ENVIRONMENT



16-535-EN

Excellent abrasion resistance extending glove life, reinforced, thumb crotch, cut resistance C.

Sizes: 7-8-9-10-11 (6-12 on request)

C

OILY & DRY ENVIRONMENT



16-1835R-EN

Excellent abrasion resistance and grip on dry or oily surfaces, high tactile sensitivity and dexterity, each pair is made from PET plastic bottles and reduces 29,16 g of CO₂ emissions per pair.

Sizes: 6-7-8-9-10-11-12

NEW

STYLE	GAUGE	EN388	EN407	COATING	COATING COVERAGE	LINER	GREEN HEART	SIZE	PACKAGING
16-319-EN	18	3X41B		PU	Palm & Fingers	PolyKor™ X7™		7 - 11	poly bag 12 / 72
16-323-EN	15	4X31B	X1XXXX	Nitrile Foam	Palm & Fingers	PolyKor™		7 - 11	poly bag 12 / 72
16-368-EN	18	4X31C		NeoFoam®	Palm & Fingers	PolyKor™ X7™		7 - 11	poly bag 12 / 72
16-533-EN	13	4X41C		PU	Palm & Fingers	PolyKor™		7 - 11	poly bag 12 / 72
16-535-EN	13	4X43C		PU	Palm & Fingers	PolyKor™		7 - 11	poly bag 12 / 72
16-1835R-EN	18	4X42C	X1XXXX	Nitrile Foam	Palm & Fingers	Recycled plastic	Yes	6 - 12	bundle 6 / 72

NEW
 DRY ENVIRONMENT

21 GAUGE



16-541-EN

21 gauge liner offers the better dexterity and tactile sensitivity in the market, reinforced thumb crotch, Deko-Tex, touchscreen compatible, cut resistance D.

Sizes: 6-7-8-9-10-11 (12 on request)

NEW
 OILY ENVIRONMENT



16-345OR-EN (alternative to 07259)

Raised micro dots on double-dipped nitrile micro-surface coating helps extend glove life, reinforced thumb crotch, cut resistance D, orange Hi-Vis for better visibility.

Sizes: 6-7-8-9-10-11 (12 on request)

NEW
 OILY ENVIRONMENT



16-350-EN (alternative to 07299N)

Double-dipped nitrile micro-surface coating provides an excellent abrasion resistance, excellent grip on dry surfaces and oil resistance.

Sizes: 7-8-9-10-11 (6-12 on request)

 DRY ENVIRONMENT



16-560-EN

Excellent abrasion resistance extending glove life, cut resistance D.

Sizes: 7-8-9-10-11 (6-12 on request)

 DRY ENVIRONMENT



16-560E (alternative to 07254)

Excellent abrasion resistance extending glove life, cut resistance D.

Sizes: 7-8-9-10-11 (6-12 on request)

 OILY ENVIRONMENT



16-854-EN

Gauge 18. PolyKor™ support is lightweight and provides excellent dexterity, tactile sensitivity, resistance to abrasion, as well as superior grip on wet, dry and slightly oily surfaces.

Sizes: 7-8-9-10-11 (6-12 on request)

STYLE	GAUGE	EN388	COATING	COATING COVERAGE	LINER	GREEN HEART	SIZE	PACKAGING
16-541-EN	21	3X31D	PU	Palm & Fingers	PolyKor™		6 - 11	poly bag 12 / 72
16-345OR-EN	13	4X44D	Nitrile Microsurface with dots	Palm & Fingers	PolyKor™		6 - 11	poly bag 12 / 72
16-350-EN	13	4X43D	Nitrile Microsurface	Palm & Fingers	PolyKor™		7 - 11	poly bag 12 / 72
16-560-EN	13	4X42D	PU	Palm & Fingers	PolyKor™		7 - 11	poly bag 12 / 72
16-560E	13	4X42D	PU	Palm & Fingers	PolyKor™		7 - 11	poly bag 12 / 72
16-854-EN	18	4X42D	Nitrile Foam	Palm & Fingers	PolyKor™		7 - 11	poly bag 12 / 72

CUT-RESISTANT

NEW
CUT D OILY ENVIRONMENT



16-CUT229MS

Double-dipped nitrile micro-surface coating helps extend glove life, fully coated for liquid-proof properties.
 Sizes: 8-9-10-11

NEW
CUT E DRY, OILY OR WET ENVIRONMENT



16-645LG-EN

Excellent abrasion resistance extending the glove life, offers increased comfort and breathability.
 Sizes: 7-8-9-10-11

CUT E DRY, OILY OR WET ENVIRONMENT



16-313-EN

PolyKor™ blended shell with X7™ technology offers high cut resistance and durability with ultra-thin liners provides superior grip in wet/dry conditions.
 Sizes: 7-8-9-10-11

NEW
CUT F DRY OR OILY ENVIRONMENT



16-586-EN

High performance work glove designed for maximum protection and durability. Steel reinforcement for overall strength and durability.
 Sizes: 7-8-9-10-11

NEW
CUT F DRY OR OILY ENVIRONMENT



16-856-EN

High performance work glove designed for maximum protection and durability. Steel reinforcement for overall strength and durability.
 Sizes: 7-8-9-10-11

NEW
CUT F DRY OR OILY ENVIRONMENT



16-366-EN only on request

Seamless construction offers increased comfort and breathability. PolyKor™ shell is lightweight and provides excellent dexterity, tactile sensitivity and cut resistance.
 Sizes: 6-7-8-9-10-11

STYLE	GAUGE	EN388	EN407	COATING	COATING COVERAGE	LINER	GREEN HEART	SIZE	PACKAGING
16-CUT229MS	13	4X43D		Nitrile Microsurface	Full hand	PolyKor™		8 - 11	poly bag 12 / 72
16-645LG-EN	13	4X42E		PU	Palm & Fingers	PolyKor™		7 - 11	poly bag 12 / 72
16-313-EN	18	3X42E		LATEX Crinkle	Palm & Fingers	PolyKor™ X7™		7 - 11	poly bag 12 / 72
16-586-EN	18	4X42F		PU	Palm & Fingers	HPPE/Steel/Polli/Spandex		7 - 11	bundle 12 / 72
16-856-EN	18	4X42F		Nitrile Foam	Palm & Fingers	HPPE/Steel/Polli/Spandex		7 - 11	bundle 12 / 72
16-366-EN	13	4X42F	X1XXXX	Nitrile Foam	Palm & Fingers	PolyKor™		6 - 11	poly bag 12 / 72



PRECISION

NEW

DRY
ENVIRONMENT

OILY OR WET
ENVIRONMENT



33-E118

Excellent abrasion resistance extending glove life, 18 gauge liner offers high dexterity and tactile sensitivity.

Sizes: 6-7-8-9-10-11



34-315-EN

Nitrile Foam coating offers a high abrasion resistance for precision handling, foam nitrile coatings are breathable and durable.

Sizes: 6-7-8-9-10-11

STYLE	GAUGE	EN388	EN407	COATING	COATING COVERAGE	LINER	SIZE	PACKAGING
33-E118	18	3121X		PU	Palm & Fingers	Nylon	6 - 11	poly bag 12 / 120
34-315-EN	15	4121X	X1XXXX	Nitrile Foam	Palm & Fingers	Polyester	6 - 11	bundle 12 / 120

G-Tek
BY PIP

HAND PROTECTION

GENERAL PURPOSE

GENERAL PURPOSE

NEW

OILY ENVIRONMENT



34-M1001/FC-ET blister
Full nitrile coating offers great abrasion resistance and outstanding wet/dry grip, comfort, finger dexterity, water proof properties.
Sizes: 8-9-10-11 (6-7-12 on request)

WET ENVIRONMENT



55-AG317-EN only on request
Latex Micro-Surface coating provides a superior grip in wet and dry conditions, high comfort, dexterity, and breathability.
Sizes: 7-8-9-10-11 (6-12 on request)

WET ENVIRONMENT



55-1600-EN only on request
Full hand Latex Micro-Surface double coating provides a superior grip in wet and dry conditions, keep your hands dry in wet conditions.
Sizes: 7-8-9-10-11 (6-12 on request)

OILY OR WET ENVIRONMENT

SUN PROTECTION



34-425NEO-EN
Solar protection (UPF 50+), maximum wearer comfort and sensitivity, high abrasion and tear resistance level while providing an un-restricted second skin fit and feel.
Sizes: 6-7-8-9-10-11 (6-12 on request)

STYLE	GAUGE	EN388	COATING	COATING COVERAGE	LINER	SIZE	PACKAGING
34-M1001/FC-ET	13	3121X	Nitrile	Full hand	Nylon	8 - 11	blister 12 / 120
55-AG317-EN	13	2121X	LATEX microsurface	Palm & Fingers	Polyester	7 - 11	poly bag 12 / 120
55-1600-EN	15	2131X	LATEX microsurface	Full hand	Polyester	7 - 11	poly bag 12 / 72
34-425NEO-EN	15	4121X	Nitrile Foam	Palm & Fingers	Polyester/Spandex	6 - 11	poly bag 12 / 120

COLD / CUT

C

OILY OR WET ENVIRONMENT



41-1415-EN
Excellent thermal insulation, superior grip, and high abrasion resistance, fully coated flat nitrile helps keep hands dry in wet applications.
Sizes: 8-9-10-11

B

WET OR OILY ENVIRONMENT

NEW



41-8150R-EN
Excellent thermal insulation, superior grip and high comfort, rapidly evaporates moisture from the skin, each pair is made from P.E.T. plastic bottles and reduces 80,83g of CO₂ emissions per pair.
Sizes: 6-7-8-9-10-11 (12 on request)



900629 G-TEK GLOVE DISPLAY STAND
Supplied without items

STYLE	GAUGE	EN388	EN407	EN511	COATING	COATING COVERAGE	LINER	GREEN HEART	SIZE	PACKAGING
41-1415-EN	15	4X32C	X2XXXX	X2X	Nitrile Foam	Palm, fingers & Knuckles	Acrylic PolyKor™		8 - 11	poly bag 12 / 72
41-8150R-EN	10	2X42B		X2X	LATEX microsurface	Palm & Fingers	Recycled plastic	GRS	6 - 11	bundle 6 / 72



Grippaz® 
BY PIP

HAND PROTECTION
GRIPPAZ®

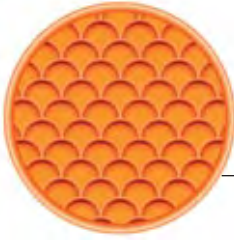

UNBEATABLE GRIP
THANKS TO PATENTED
FISH SCALE PATTERN



246BK

Grippaz™ Technology features a fish scale pattern that provides unparalleled grip performance. Offers maximum comfort, multiple use durability and dexterity.

Sizes: S/7- M/8 - L/9 - XL/10 - 2X/11



246OR

Grippaz™ Technology features a fish scale pattern that provides unparalleled grip performance. Offers maximum comfort, multiple use durability and dexterity.

Sizes: S/7- M/8 - L/9 - XL/10 - 2X/11



306DB

Grippaz™ Technology features a fish scale pattern that provides unparalleled grip performance. Offers maximum comfort, multiple use durability and dexterity.

Sizes: M/8 - L/9 - XL/10 - 2X/11



STYLE	EN374-1	EN374-5	MATERIAL	COLOR	THICKNESS	LENGTH	GRIP PATTERN	POWDER	SIZE	PACKAGING
246OR	TIPO B JKTP	VIRUS	Nitrile	Orange	0.1524 mm	24 cm	Fish Scale	Free	7 - 11	50 pcs. / 500 pcs.
246BK	TIPO B JKTP	VIRUS	Nitrile	Black	0.1524 mm	24 cm	Fish Scale	Free	7 - 11	50 pcs. / 500 pcs.
306DB	TIPO B JKTP	VIRUS	Nitrile	Blue	0.1524 mm	30 cm	Fish Scale	Free	8 - 11	50 pcs. / 500 pcs.



ISSALINE

BY **PIP**

Protection of breathing, eyes, head.

Welcome to our catalog dedicated to Personal Protective Equipment (PPE), your one-stop shop for industry dealers and specialists. Ensuring safety in the workplace is crucial, and PPE is essential for creating a safe working environment for both you and your customers.

OUR COMMITMENT TO SAFETY

We are dedicated to offering top-quality PPE that meets your customers' safety requirements. Every item in our inventory is meticulously chosen to guarantee reliability and long-lasting performance. We are here to address inquiries, offer technical guidance, and assist your business in any way possible. Ensuring your safety and that of your customers is our utmost priority.

Note: The certification values shown in this catalogue may vary due to the continuous updating process; for exact data, please ask for updated technical data sheet.



FILTERING FACEPIECES BREATHE SAFE

We begin with our range of filtering facepieces, designed to offer maximum respiratory protection. Each product has been carefully selected to ensure maximum efficiency in filtering particles and harmful agents. Our filtering facepieces are a reliable choice for ensuring respiratory safety in your workplace.

APPROVED
DOLOMITE POWDER

DS8732D

FFP3 - NR D

EN149:2001+A1:2009

Facepiece filter for very toxic dust (Eg. Asbestos, cement, quartz) and water based mist and fumes. The level of protection is equal to 50 times the TLV (Danger threshold limit value). The mask is equipped with one exhalation valves consequently breathing is made easier.

Sizes: one size

Minimum order: 1 box of 5 pcs.

Full box: 12 box of 5 pcs.



DS7322N

FFP2 - NR

EN149:2001+A1:2009

Facepiece filter for toxic dust and water-based mist and fumes. The level of protection is equal to 12 times the TVL (Danger threshold limit value). The mask is equipped with an exhalation valve and an intermediate layer of activated carbon. Recommended for light welding fumes and in the presence of unpleasant odors.

Sizes: one size

Minimum order: 1 box of 12 pcs.

Full box: 12 box of 10 pcs.



DS7822N

FFP2 - NR

EN149:2001+A1:2009

Facepiece filter for toxic dust and water-based mist and fumes. The level of protection is equal to 12 times TVL (Danger threshold limit value). The mask is equipped with an exhalation valve.

Sizes: one size

Minimum order: 1 box of 10 pcs.

Full box: 12 box of 10 pcs.



DS7820N

FFP2 - NR

EN149:2001+A1:2009

Facepiece filter for toxic dust and water-based mist and fumes. The level of protection is equal to 12 times the TVL (Danger threshold limit value).

Sizes: one size

Minimum order: 1 box of 20 pcs.

Full box: 12 box of 20 pcs.





DS7532N

FFP3 - NR
EN149:2001+A1:2009

Foldable facepiece filter for very toxic dust and water-based mist and fumes. The level of protection is equal to 50 times the TLV (Danger threshold). The mask is equipped with one exhalation valve and is sealed individually for greater hygiene.

Sizes: one size

Minimum order: 1 box DISPESER of 10 pcs.

Full box: 12 box DISPENSER of 10 pcs.



DS7522N

FFP2 - NR
EN149:2001+A1:2009

Foldable facepiece filter for toxic dust and water-based mist and fumes. The level of protection is equal to 12 times the TLV (Danger threshold). The mask is equipped with an exhalation valve, individually sealed for greater hygiene.

Sizes: one size

Minimum order: 1 box DISPESER of 10 pcs.

Full box: 12 box DISPENSER of 10 pcs.



DS9200

FACEPIECE NO PPE

Disposable and hygienic mask to protect the product. He has no level of protection.

Sizes: one size

Minimum order: 1 box of 50 pcs.

Full box: 20 box of 50 pcs.



APPROVED
DOLOMITE POWDER

1DS8732D

FFP3 - NR D
EN149:2001+A1:2009

Facepiece filter for very toxic dust and water-based mist and fumes. The level of protection is equal to 50 times the TLV (Danger threshold). The mask is equipped two exhalation valves.

Sizes: one size

Blister: contains 2 pcs.

Minimum order: 5 blister.

Full box: 10 blister.



1DS7322N

FFP2 - NR D
EN149:2001+A1:2009

Facepiece filter for toxic dust and water-based mist and fumes. The level of protection is equal to 12 times the TLV (Danger threshold). The mask is equipped an exhalation valve and an intermediate layer of activated carbon (For welding odors and fumes).

Sizes: one size

Blister: contains 2 pcs.

Minimum order: 5 blister.

Full box: 20 blister.



1DS7822N

FFP2 - NR D
EN149:2001+A1:2009

Facepiece filter for toxic dust and water-based mist and fumes. The level of protection is equal to 12 times the TLV (Danger threshold). The mask is equipped with an exhalation valve.

Sizes: one size

Blister: contains 2 pcs.

Minimum order: 5 blister.

Full box: 20 blister.



1DS9200

MASCHERINA NO DPI

Facepiece filter for toxic dust and water-based mist and fumes. The level of protection is equal to 12 times the TLV (Danger threshold). The mask is equipped with an exhalation valve.

Sizes: one size

Blister: contains 10 pcs.

Minimum order: 1 blister.

Full box: 20 blister.





HARD HATS - PROTECT YOUR HEAD, SAVE YOUR LIFE

Our work helmets are constructed with the utmost attention to detail to provide optimal protection. Whether you are in construction, manufacturing or any other hazardous environment, our hard hats are your shield to protect your head from hazards.

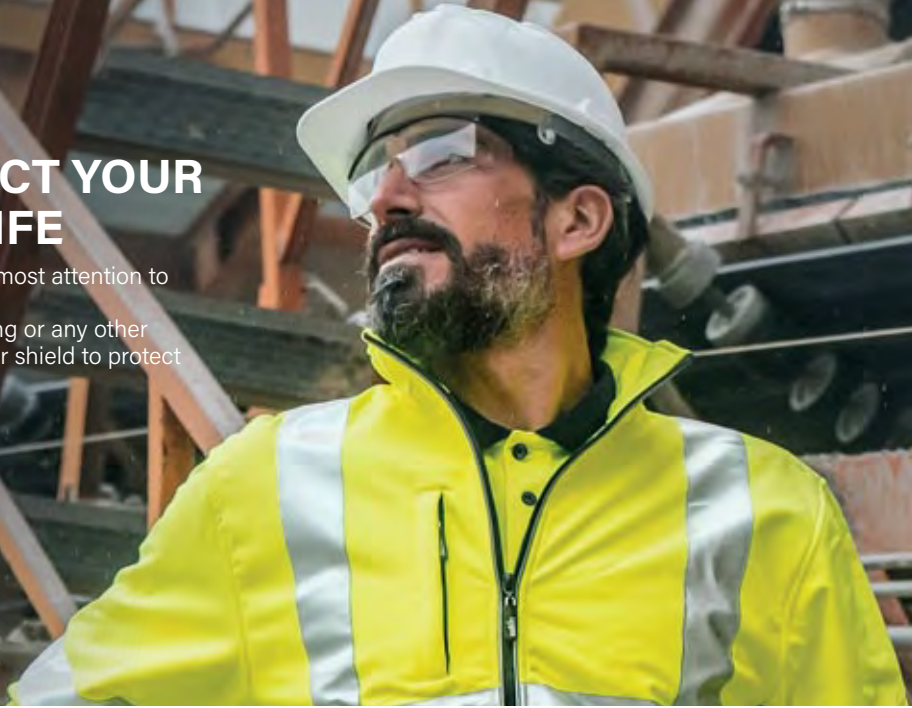

09025 BERICO SAFETY HELMET EN397

The reasonably priced helmet in HD polyethylene, with internal harness in removable fabric, 440 volt dielectric insulation, with sweatband.

Sizes: one size

Colour:

010 yellow,

050 white,

070 red,

110 blue,

030 orange.

Full box: 24 pcs. (assembled)



09026 CHIN STRAP

For safety helmets

Sizes: one size adjustable

Colour: random.

Minimum order: 10 pcs.

Full box: 50 pcs.



09027 BADGE HOLDER

to be applied only on the Berico 09025 helmet.

Colour: transparent.

Minimum order: 12 pcs.

Full box: 24 pcs.



AUTOMATICALLY ADJUSTABLE

09028A VENTED SAFETY HELMET EN397

Certified helmet, automatic adjustment of the harness with patented syste.

Sizes: one size

Colour:

010 yellow,

050 white,

other colours available on request.

Full box: 28 pcs. (assembled)



09128 MIAMI EN155 IF

Goggles with wrap-around polycarbonate lenses for excellent adherence to the face; the glasses have a double treatment anti-scratch and anti-fog. Frame and lens colors: blue frame / clear lenses and blue frame / smoked lenses.

Colore lente: 000 colorless, 080 fumé.

Minimum order: 10 pcs. individually wrapped.

Full box: 50 pcs.





VERY LIGHT



**AK9050N
HELMET FALKNER FOR SCAFFOLDING**
EN397:2012

Helmet in mountain style with outer shell in ABS and inner shell for shock absorption in polystyrene. One size adjustable by rack, equipped with micro frontal airing holes.

Compatible headphones: AK9040 Sordin, MXG140 Moldex and all those with universal Euro connection (30 mm).

Note: it is not possible to use a visor.

Sizes: one size adjustable by rack.

Colour:

- 010 yellow,
- 030 orange,
- 040 blu,
- 050 white,
- 060 black (only on request)
- 070 red.



Full box: 6 pcs.



TOP OF THE RANGE



**AK9055
HELMET SASSONGHER FOR SCAFFOLDING**
EN397:2012

Top safety helmet in mountain style with outer shell in ABS and inner shell in EPS for shock absorption, also certified for lateral deformation. One size, adjustable by rack, with airy shell by large holes, covered with high density breathable fabric.

Note: visors or headphones cannot be used.

Sizes: one size adjustable by rack.

Colour:

- 010 yellow,
- 030 orange,
- 040 blu (only on request),
- 050 white,
- 060 matte black,
- 070 red (only on request)



Full box: 6 pcs.





AK9057 TEXEL HELMET EN 397:2012

Mountain style safety helmet with high impact absorption in addition to the requirements of EN397 the safety helmet it is also certified for lateral deformation, electrical insulation and low temperatures. It has a slot for fixing a head touch. The helmet has Euro universal connections (eg. S42V or S41C Centurion) for ear defenders and face visors (see sidebar). Reflective stickers supplied separately.

Composition: ABS outer shell and expanded polystyrene (EPS) inner shell.

Sizes: One size adjustable through a micrometric rack.

Colour: 010 yellow, 030 orange.

Only on request 040 blu, 050 white, 060 black, 070 red.



Full box: 6 pcs.



REFLECTIVE
STICKERS
SUPPLIED
SEPARATELY.

TOP OF RANGE



MADE
IN ITALY

AK9020 Visor sold
separately



AK9030 Visor sold
separately

ACCESSORIES KIT FOR AK9057 AND AK9060



AK9030 long visor
EN 166:2001 1B

16 cm, UV filter, for helmets AK9057 and AK9060.



AK9020 Short visor
EN 166:2001 1B

UV filter, for helmets AK9057 and AK9060.



**AK9021 Short visor
with rim**
EN 166:2001 1B

Edged, UV filter, for helmets AK9057 and AK9060.



AK9035 Metal visor

18 cm, for hard hats AK9057, AK9060 to be combined with headphones AK9040 or, for use without headphones, with adapter AK9037.



AK9040 Headphones

Black color (060) SNR 28 to be used alone or with AK9035 metal visor.

Colour: 060 black



Forestry Kit =

AK9060 (or AK9057) + AK9035
+ AK9040



Brush cutter kit =

AK9060 (or AK9057) + AK9035+AK9037

AK9060 VENTILATED TEXEL PLUS

EN 397:2012

Mountain-derived helmet with high impact absorption. In addition to the requirements of EN397, the helmet is certified for low temperatures (-40 °). One size adjustable by means of a micrometric rack. Equipped with loops to fix a possible lamp holder buckle. Helmet equipped with high visibility inserts.

Composition: ABS outer shell and expanded polystyrene (EPS) inner shell.

Sizes: One size adjustable through a micrometric rack.

Colour: 011 yellow fluo, 031 orange fluo, 050 White.



Full box: 6 pcs.



VENTILATED



MADE
IN ITALY

SUPPLIED WITH
STICKERS
RETROREFLECTIVE
ALREADY APPLIED



AK9021 visor sold
separately



WELDING PROTECTION

Welding is an art that requires specialized equipment, and protection is critical. Discover our line of products for protection during welding, including blackout masks and heat-resistant gloves designed to ensure maximum safety during your welding activities.



10002
FLAT SCREEN FOR WELDING
EN175

Flat screen in the cellulose fiber material for better quality and durability, visor size 75x98 mm.
Full box: 20 pcs.
N.B.: SUPPLIED WITHOUT GLASS



10407
TILTED SCREEN FOR WELDING
EN175

Tilted screen in the cellulose fiber material for better quality and durability, visor size 75x98 mm.
Full box: 20 pcs.
N.B.: SUPPLIED WITHOUT GLASS



S800DF
TILTING SCREEN HELMET FOR WELDING
EN175

Special tilting screen helmet in thermoplastic visor size 75x98 mm
Full box: 20 pcs.
N.B.: SUPPLIED WITHOUT GLASS

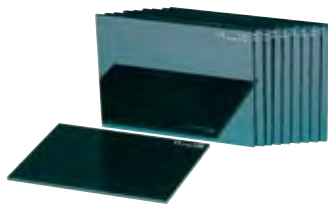

09062
ADIACINIC GLASS FOR THE SCREEN
EN169

Protane adiacinic glass DIN11 size 75x98 mm
Full box: 5 cont. (of 100 pcs.)

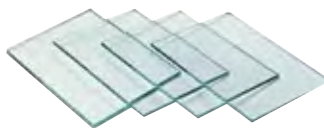

09060N
COLOURLESS GLASS FOR THE SCREEN
EN166

Colourless glass size 75x98 mm adiacinic glass protection (Art. 09062)
Full box: 1 pack of 100 pcs.



DS7322N
FFP2 - NR - EN149:2001-A1:2009

Facepiece filter for toxic dust and water-based mist and fumes. The level of protection is equal to 12 times the TVL (Danger threshold limit value). The mask is equipped with an exhalation valve and an intermediate layer of activated carbon. Recommended for light welding fumes and in the presence of unpleasant odors.

Sizes: one size
Minimum order: 1 box of 12 pcs.
Full box: 12 box of 10 pcs.



000170
GLASSES 317N-T
EN 166

Glasses with ear piece side shields, transparent tempered lens.
Full box: 20 pcs.



000175
GLASSES 317N-VT
EN175

Glasses with ear piece side shields, and green DIN 5 lenses
Full box: 20 pcs.



000187
GLASSES 317N-C
EN 166

Glasses with ear piece side shields, and clear blast safety polycarbonate lenses
Full box: 20 pcs.

000014 only on request
LENSES 317N
EN166
Anti blast, and colourless polycarbonate shaped lenses
Minimum order: 1 pack of 25 pairs

000018 only on request
LENSES 317N
EN166
Anti blast, and colourless tempered glass shaped lenses
Minimum order: 1 pack of 25 pairs

000063 only on request
LENSES 317N
EN166 EN169
Anti blast and green shaped lenses, tempered DIN 5
Minimum order: 1 pack of 25 pairs





HTO41
EN ISO 11612:2008, A, B1, C1
EN ISO 11611:2007 Class 1 A1
EN1149-3:2004
EN1149-5:2008

Flame retardant balaclava for welders. The extended length provides extra protection for the neck, upper chest and back.
Colour: black
Sizes: one size.
Full box: 1 pcs.



VITCIV
CE Cat. 1
100% cotton fireproof Saharan head cover 300 g/m²
Full box: 1 pcs.



VITCIVS
CE Cat. 1
100% cotton fireproof Saharan head cover 300 g/m²
Full box: 1 pcs.



ST2049
SLEEVES EN 11611
Certified sleeves for welding in brown crust with buttons at the cuffs. back attachment with elastic strings for easy movement. Length 65 cm. One size.
Full box: 1 pc.



ST2011
JACKET EN 11611
Certified welding jacket, in top of the range brown crust leather, with uniform thickness. Kevlar seams, protected studs, with a cotton neck line.
Sizes: L-XL-XXL
Full box: 1 pcs.



ST2022
GAITERS EN 11611
Apron certificate for welders, top of the range brown crust leather, with uniform thickness, and extra strong around the waist 57x30cm. Size 90x60cm
Full box: 1 pcs.



ST2039
GAITERS EN 11611
Certified welding gaiters, in brown crust and gray over the shoe. Shin guard and the instep, covering and perfectly protects the safety shoes. Adjustable velcro closure. Height 40 cm One size.
Full box: 1 pcs.



07180
LEATHER APRON
Completely crusted approx. 60x90cm.
Full box: 5 packs (of 10 pcs.)



07190
LEATHER GAITERS
Completely in crust, with velcro side closure and adjustable strap under the sole.
Full box: 5 conf. (of 10 pairs)

Cuciture in KEVLAR®



EN 388 EN12477-tipo A
EN 407
3333 414X4X

07121K
COWHIDE SPLIT LEATHER GLOVES
seams Kevlar®

EN 388 4133X - EN12477 tipo A EN407 413X4X
Glove made with superior cowhide crust leather with heat-resistant treatment (THT). It withstands contact heat at a temperature of 100° C for 15 seconds. Split leather Kevlar seam protector, palm and cuff back lining.
Composition: cowhide split leather **Colour:** red
Total length cm: 38
Size: 10 **Package:** 6 pa. **Full box:** 60 pa.



EN 388 EN12477-tipo A
EN 407
3333 414X4X

07122
GLOVE REINFORCED WITH COWHIDE SPLIT LEATHER
Glove completely made with split leather, 15 cm cuff.
Reinforced palm.
Sizes: 10
Full box: 60 pa.



EN 388 EN12477-tipo A
EN 407
3233 413X4X

07127
COWHIDE SPLIT LEATHER GLOVES
Glove completely made with split leather, 15 cm cuff.
Sizes: 10
Full box: 60 pa.

Stitching in ARAMIDIC fibre
- abrasion-resistant
- sparks resistant



36140 EBR0
EN ISO 20345 S3 SRC
Chaussure haute pour soudeur avec tige en cuir aspect grainé, large rabat par-dessus la languette (élastique sans lacets), fermeture avec boucle métallique pour un déchaussement rapide. Coutures en fibre aramide qui garantissent une meilleure résistance, mais aussi une protection contre les étincelles de soudage. Semelle en PU double densité.





MODULAR SCREEN



85854

Lanskit 1460

MOUNTABLE SCREEN complete with LANSARC OR fencing full from 0.4mm, lightweight, easy to assemble and move.
Size Screen: L.1460 x H.1950mm. UNI EN 1598

17116P (replaces 17118P) eight 1.8 **only on request**

Striped fencing LANSARC OR. STRIPED FENCE
Thickness 0.4mm Width 2 meters, height 1.8 meters, transparent and protective to UV, IR and Blue Light rays, easy to assemble, and allows walkways.
Recommended for: large fixed locations with the need of walkways. UNI EN 1598

18116P (replaces 18118P) **only on request**

Striped fencing LANSARC OR. STRIPED FENCE
Thickness 1mm Width 2 meters, height 1.8 meters, transparent and protective to UV, IR and Blue Light rays, easy to assemble, and allows walkways. Recommended for: large fixed locations with the need of walkways. UNI EN 1598



8501

Metal ring striped fencing - 1 pcs.

BOX FISSI TRANS-ARC:

Simple, economical and easy to assemble solutions for the construction of standard fixed welding boxes. With a single code it is possible to purchase a corner, two or four-sided perimeter protection with predefined dimensions. The kit is complete and ready for assembly, has a standard height of 2 meters and includes uprights, wall fastenings, rails, hooks and Lansarc OR striped curtains, height 1600 x 0.4 mm. Customized solution also for different sizes.

36070* Three-sided welding box 3x4x3mt

36090* Three-sided welding box 3x5x3mt

35030* Corner welding box 4x2mt

35070* Corner welding box 3x3mt

35090* Corner welding box 5x3mt

37060* Island welding box 3x4x3x4mt

37080* Island welding box 3x5x3x5mt

* only on request

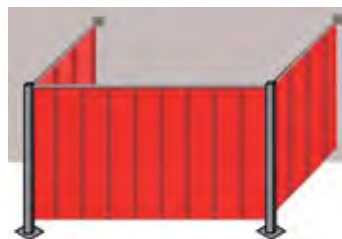



09210
CREPUSCULAR BLINKER
Blinker with pole attachment, with fluorescent colour base and crepuscular switch (automatically activates the flashing light when it becomes dark). 2 batteries of 6 volts not included.
Colour:
Yellow (010) with intermittent light
Red (070) with fixed light
Full box: 10 pcs.

09215 **only on request**
AUTOMATIC FLASHER
Pole-mounted spotlight, with base, in fluorescent color and flashing switch (activates automatically in darkness), LED light, needs only 1 6-volt battery. Not included.
Colour: yellow.
Full box: and minimum order quantity: 10 pieces per box.



09212
BATTERY FOR BLINKER
For the blinker 09210, 6 volt output voltage.
Full box: 24 pcs.
Minimum order: 1 pcs.



09300
WARNING TAPE
ONE ROLL PER BOX
Made of plastic, coloured in alternate red/white bands. Length 200 meters. h 70 mm.
Full box: 30 pcs. per box. (in individual boxes of a roll), minimum 30 pcs.



09305
WARNING TAPE IN GROUPS OF 5 PCS.
Made of plastic, coloured in alternate red/white bands. Length 200 meters. h 70mm.
Full box: 6 pieces (in groups of 5 rolls)



S2002PE
SIGNALING CONE
Polyethylene with 1 painted strip.
Dimension: 34 cm.
Full box: 20 pcs.

S2003PE
SIGNALING CONE
Polyethylene with 2 painted strip.
Dimension: 54 cm.
Full box: 10 pcs.

S2002PVC
SIGNALING CONE
In PVC, it has 1 reflective strips.
Dimension: 34 cm.
Full box: 20 pcs.

S2003PVC
SIGNALING CONE
In PVC, it has 2 reflective strips.
Dimension: 54 cm.
Full box: 10 pcs.



S2001
SPROCKET PEDESTAL
Made of plastic, height 90 cm. Ballasted base minimum order: 12 pcs.
Full box: 24 pcs.

SR2004
JOINT FOR 5.5 mm CHAIN
In plastic material,
Full box: 1 pack. from 10 pcs.

SR2005
JOINT FOR 7.5 mm CHAIN
In plastic material,
Full box: 1 pack. from 10 pcs.

S20040
CHAIN
Made of plastic. Length 25 mt. 5,5 mm thick
Full box: 8 pcs.

S20050
CHAIN
Made of plastic. Length 25 mt. 7.5 mm thick
Full box: 4 pcs.



1108 **only on request**
SIGNALING CONE
Made of polyethylene with 1 reflective band. 30 cm size.
Full box: 10 pcs.

1109 **only on request**
SIGNALING CONE
Made of polyethylene with 1 reflective band 20 cm. 45 cm size.
Full box: 10 pcs.

1118 **only on request**
5-meter polyethylene chain + two 5.5-mm polyethylene chain link links 5-meter polyethylene chain in a bag, plus two link links.
Full box: 30 pcs.



1119 **only on request**
20-mm mushroom-shaped formwork protection.
Minimum order quantity: 400 pcs.



1120 **only on request**
35 mm mushroom-shaped formwork protection.
Minimum order quantity: 300 pcs.





S2000P
SCOOP SIGNS
Plastic, double-sided reflective green color, red. Diameter 30 cm.
Full box: 60 pcs.



MULTIPURPOSE TARPAULIN **only on request**
Lightweight, waterproof, polyethylene, durable and with eyelets.
Colour: blue. UV. treatment.

Art.	Dimensions m.	Packaging:
00923	2x3	30 pcs.
00934	3x4	20 pcs.
00946	4x6	8 pcs.
00958	5x8	6 pcs.
00961	6x10	5 pcs.



S2070
STANDS FOR SIGNS
Plastic, double-sided plus opens and closes. Sign «Caution wet floor» included.
Signs are interchangeable in the format 20x20 cm or 20x30 cm.
Full box: 6 pcs.



01113 **only on request**
REFLECTIVE BAND.
Sewable band with height 5 cm.
in a roll of 200 mt.
Full box: 1 rolls
3M Scotchlite®

09428
LOWER BACK SUPPORT
WHIT BRACES

Offers certain help to prevent back pain. It improves posture, and corrects the technique of lifting weights.
Colour: black
Sizes: L-XL
Full box: 10 pcs.



bouton[®]

BY PIP

Eye protection



PROTECT AGAINST HARMFUL BLUE LIGHT

Overexposure to blue light, including smart phones, tablets and computer screens, have been known to cause eyestrain, fatigue and possibly contribute to long term macular degeneration. I/O Blue lenses are uniquely coated to help filter out harsh blue light and improve worker comfort and visual acuity. Lenses are treated with a contrast booster to enhance color contrast.



TAKE ANTI-REFLECTIVE PLUS[™] TECHNOLOGY OUTDOORS WITH MIRROR PLUS LENSES

A mirror coating on the face of the lens will deflect sunlight from the wearer's eyes, delivering noticeably less glare and reflection than standard gray lenses. Anti-Reflective Plus[™] coating on the back of the lens significantly reduces light reflecting back into the eye for enhanced comfort and performance.



THE CLOSEST THING TO NOT WEARING GLASSES

Bouton[®] Anti-Reflective Plus[™] lenses allow an astounding 96% Visible Light Transmission (VLT) compared to the 88-90% VLT provided by standard clear lenses. Durable Anti-Reflective Plus[™] coating significantly reduces the amount of light that reflects back into the wearer's eyes providing ultimate visual acuity. Inspect, sort and see with more clarity – and less eye fatigue.

TECHNOLOGIES DE VERRRES



FILTER REFLECTED SUNLIGHT FOR A CLEAR VIEW

Reflected sunlight from smooth surfaces, such as water, pavement and snow can dangerously hinder vision and cause significant eyestrain. Polarized XL5™ lenses filter the scattered light by controlling the angle at which it enters the lens. The result is clearer vision of the surrounding area and greatly reducing eye glare.



REDUCE GLARE FROM OVERHEAD LIGHT

High-powered overhead lights, such as fluorescent and mercury lighting, can cause glare that increases eye strain. Gradient lenses feature a slight mirror coating on the top portion of the lens, reducing glare, while the remainder of the lens remains clear. As a result, workers are still able to see clearly when looking straight ahead or down at their work.



PROVIDING WORKERS CLEAR VISION IN EXTREME CONDITIONS

Lenses fog for many reasons, all of which are related to ambient temperature and moisture in the air. When a rapid temperature change occurs, micro-water droplets in the air will collect on untreated lenses, causing the lenses to fog and impede vision.

bouton
BY PIP

EYE PROTECTION
SPORT

SPORT

I-TEK™

Pivoting and flexible bi-material temples provide the most comfortable nonslip fit, the soft flange co-injected directly all around the lens provides a full around fit and appropriate dust and particle protection from different sides.

Lens Material: polycarbonate
Temples Material: co-injected polycarbonate + TPE



250-95-0520-EN

Lens Technology 



250-95-1520-EN

Lens Technology 



250-95-0521-EN

Lens Technology 



250-95-0022-EN

STYLE	LENS COLOR	FRAME/TEMPLE COLOR	LENS COATING	NOSE BRIDGE	BASE CURVE	WEIGHT	LENS MARKING	FRAME MARKING	EN NORM	PACKAGING
250-95-0520-EN	Clear	Dark Gray/Light Gray	Anti-Scratch K, Fogless 3Sixty N	Soft adjustable anti-slip	9,5	25 g	2C-1,2 P 1 FT KN CE	P EN166 FT CE	EN 166 / EN 170 / EN 172	12 / 144
250-95-1520-EN	Clear	Light Blue/Light Gray	Anti-Scratch K, Fogless 3Sixty N	Soft adjustable anti-slip	9,5	25 g	2C-1,2 P 1 FT KN CE	P EN166 FT CE	EN 166 / EN 170 / EN 172	12 / 144
250-95-0521-EN	Gray	Dark Gray/Light Gray	Anti-Scratch K, Fogless 3Sixty N	Soft adjustable anti-slip	9,5	25 g	5-2,5 P 1 FT KN CE	P EN166 FT CE	EN 166 / EN 170 / EN 172	12 / 144
250-95-0022-EN	I/O UV400	Navy Blue/Light Gray	Anti-Scratch K, Anti-Fog N	Soft adjustable anti-slip	9,5	25 g	5-1,7 P 1 FT CE	P EN166 FT CE	EN 166 / EN 170 / EN 172	12 / 144

SQUADRON

Flexible nose bridge for higher comfort, co-injected flexible temples for a better fit.

Lens Material: polycarbonate
Temples Material: co-injected polycarbonate + TPE



250-87-0520-EN

Lens Technology 



250-87-0020-EN



250-87-0521-EN

Lens Technology 



250-87-0021-EN

STYLE	LENS COLOR	FRAME/TEMPLE COLOR	LENS COATING	NOSE BRIDGE	BASE CURVE	WEIGHT	LENS MARKING	FRAME MARKING	EN NORM	PACKAGING
250-87-0520-EN	Clear	Red/Black	Anti-Scratch K, Fogless 3Sixty	Rubber	9	28 g	2C-1,2 P 1 FT KN CE	P EN166 FT CE	EN 166 / EN 170 / EN 172	12 / 144
250-87-0020-EN	Clear	Orange/Black	Anti-Scratch, Anti-Fog	Rubber	9	28 g	2C-1,2 P 1 FT CE	P EN166 FT CE	EN 166 / EN 170 / EN 172	12 / 144
250-87-0521-EN	Gray	Red/Black	Anti-Scratch K, Fogless 3Sixty	Rubber	9	28 g	5-3,1 P 1 FT KN CE	P EN166 FT CE	EN 166 / EN 170 / EN 172	12 / 144
250-87-0021-EN	Gray	Orange/Black	Anti-Scratch, Anti-Fog	Rubber	9	28 g	5-3,1 P 1 FT CE	P EN166 FT CE	EN 166 / EN 170 / EN 172	12 / 144

SPORT

FEROCIA

Flexible nose bridge for higher comfort, co-injected flexible temples for a better fit.

Lens Material: polycarbonate + TPR
Temples Material: PC/TPE



250-94-0120-EN



250-94-0021-EN



250-94-0020-EN

STYLE	LENS COLOR	FRAME/TEMPLE COLOR	LENS COATING	NOSE BRIDGE	BASE CURVE	WEIGHT	LENS MARKING	FRAME MARKING	EN NORM	PACKAGING
250-94-0120-EN	Clear	Orange HV/Black	Anti-Scratch, Anti-Fog	Co-injected	9	29,38 g	2C-1.2 P 1 FT CE	P EN166 FT CE	EN 166 / EN 170 / EN 172	12 / 144
250-94-0021-EN	Gray	Orange HV/Black	Anti-Scratch, Anti-Fog	Co-injected	9	29,38 g	5-3.1 P 1 FT CE	P EN166 FT CE	EN 166 / EN 170 / EN 172	12 / 144
250-94-0020-EN	Clear UV400	Black/Red	Anti-Scratch, Anti-Fog	Co-injected	9	29,38 g	2C-1.2 P 1 FT CE	P EN166 FT CE	EN 166 / EN 170 / EN 172	12 / 144

COMMANDER

Lightweight, semi-rimless design offers extensive eye coverage and all day comfort, bayonet style temples with non-slip rubber pads provide a secure fit.

Lens Material: polycarbonate
Temples Material: polycarbonate



250-33-1020-EN



250-33-1021-EN

STYLE	LENS COLOR	FRAME/TEMPLE COLOR	LENS COATING	NOSE BRIDGE	BASE CURVE	WEIGHT	LENS MARKING	FRAME MARKING	EN NORM	PACKAGING
250-33-1020-EN	Clear	Bronze	Anti-Scratch, Anti-Fog	PVC	9,5	24,5 g	2C-1.2 P 1 FT CE	P EN166 FT CE	EN 166 / EN 170 / EN 172	12/144
250-33-1021-EN	Gray	Bronze	Anti-Scratch, Anti-Fog	PVC	9,5	24,5 g	5-3.1 P 1 FT CE	P EN166 FT CE	EN 166 / EN 170 / EN 172	12/144

SPORT



GREEN HEART®

VICO

Reduce CO₂ emissions by average 66%, lightweight (22 g) wrap around style The VICO offers a modern, sporty, lightweight stylish curve design. The single wrap around lens provides a wide field of vision. Metal free design. Dynamic and flexible design offers comfortable and secure fit. Unique pliable soft temple tips prove cushion effect for additional comfort.

Lens Material: bio-based polycarbonate
Temples Material: bio-based polycarbonate

NEW

NEW



250-16-0020-EN



250-16-0021-EN

STYLE	LENS COLOR	FRAME/TEMPLE COLOR	LENS COATING	NOSE BRIDGE	WEIGHT	LENS MARKING	FRAME MARKING	EN NORM	PACKAGING
250-16-0020-EN	Clear	Green/Gray	Anti-Scratch, Anti-Fog	Molded	22 g	2C-1.2 P 1 FT CE	P EN166 FT CE	EN 166 / EN 170 / EN 172	12 / 144
250-16-0021-EN	Gray	Green/Gray	Anti-Scratch, Anti-Fog	Molded	22 g	5-2.5 P 1 FT CE	P EN166 FT CE	EN 166 / EN 170 / EN 172	12 / 144

ZENON ULTRA LYTE™

A new area of lightweight safety eyewear. The Ultra-Lyte is the lightest eye protection on the market and was designed to conform to the face to reduce gaps for a comfortable fit. Reduce CO₂ emissions by average 66%.

Lens Material: bio-based polycarbonate
Temples Material: bio-based polycarbonate

NEW

NEW



250-14-0020-EN



250-14-0021-EN

STYLE	LENS COLOR	FRAME/TEMPLE COLOR	LENS COATING	NOSE BRIDGE	BASE CURVE	WEIGHT	LENS MARKING	FRAME MARKING	EN NORM	PACKAGING
250-14-0020-EN	Clear	Transparent Grey	Anti-Scratch, Anti-Fog	Molded	9,5	15,7 g	2C-1.2 P 1 FT CE	P EN166 FT CE	EN 166 / EN 170 / EN 172	12 / 144
250-14-0021-EN	Gray	Transparent Grey	Anti-Scratch, Anti-Fog	Molded	9,5	15,7 g	5-3.1 P 1 FT CE	P EN166 FT CE	EN 166 / EN 170 / EN 172	12 / 144

INDUSTRIAL

PLUTOR™

Eco material spectacle, reduce CO₂ emissions by average 66%. Lightweight design. Special temple design with holes provides pliability for extra comfort, contour to different head shapes. Metal free.

Lens Material: bio-based polycarbonate
Temples Material: bio-based polycarbonate



NEW



250-15-0020-EN

Z-LYTE

Modern wraparound lens style will look great on a variety of users, thin temple provides a secure fit without uncomfortable pressure points.

Lens Material: polycarbonate
Temples Material: polycarbonate



250-13-0000-EN

STYLE	LENS COLOR	FRAME/TEMPLE COLOR	LENS COATING	NOSE BRIDGE	BASE CURVE	WEIGHT	LENS MARKING	FRAME MARKING	EN NORM	PACKAGING
250-15-0020-EN	Clear	Black	Anti-Scratch, Anti-Fog	regolabile	8	21,5 g	2C-12 P 1 FT CE	P EN166 FT CE	EN 166 / EN 170 / EN 172	12/144
250-13-0000-EN	Clear	Clear	Anti-Scratch	Molded	10	18 g	2C-12 P 1 FT CE	P EN166 FT CE	EN 166 / EN 170 / EN 172	12 / 144



INDUSTRIALE

ZENON

Lightweight, rimless design provides all day user comfort, thin, flexible temples provide a secure fit without uncomfortable pressure points.

Lens Material: polycarbonate
Temples Material: polycarbonate

NEW

NEW



250-02-0020-EN



250-02-0021-EN



250-02-5529-EN

Lens Technology

FOGLESS₃SIXTY™
TECHNOLOGY

STYLE	LENS COLOR	FRAME/TEMPLE COLOR	LENS COATING	NOSE BRIDGE	BASE CURVE	WEIGHT	LENS MARKING	FRAME MARKING	EN NORM	PACKAGING
250-02-0020-EN	Clear	Navy Blue	Anti-Scratch, Anti-Fog	Molded	9,75	23 g	2C-1,2 P 1 FT CE	P EN166 FT CE	EN 166 / EN 170 / EN 172	12 / 144
250-02-0021-EN	Gray	Navy Blue	Anti-Scratch, Anti-Fog	Molded	9,75	23 g	5-3,1 P 1 FT CE	P EN166 FT CE	EN 166 / EN 170 / EN 172	12 / 144
250-02-5529-EN	Yellow	Navy Blue	Anti-Scratch, Anti-Fog	Molded	9,75	23 g	2-1,2 P 1 FT CE	P EN166 FT CE	EN 166 / EN 170 / EN 172	12 / 144

ZENON F

Removable gasket, flexible temples to provide a secure fit.

Lens Material: polycarbonate
Temples Material: polycarbonate



250-01-F020-EN

STYLE	LENS COLOR	FRAME/TEMPLE COLOR	LENS COATING	NOSE BRIDGE	BASE CURVE	WEIGHT	LENS MARKING	FRAME MARKING	EN NORM	PACKAGING
250-01-F020-EN	Clear	Black	Anti-Scratch, Anti-Fog	Molded	9,5	33 g	2C-1,2 P 1 FT CE	P EN166 FT CE	EN 166 / EN 170 / EN 172	12 / 144

PULSE

Lightweight, rimless design provides all day user comfort, universal fit nose bridge, with soft nose pads for superior comfort.

Lens Material: polycarbonate
Temples Material: polycarbonate



NEW

250-49-0000-EN

STYLE	LENS COLOR	FRAME/TEMPLE COLOR	LENS COATING	NOSE BRIDGE	BASE CURVE	WEIGHT	LENS MARKING	FRAME MARKING	EN NORM	PACKAGING
250-49-0000-EN	Clear	Clear	Anti-Scratch	PVC	9,5	22 g	2C-1,2 P 1 FT CE	P EN166 FT CE	EN 166 / EN 170 / EN 172	12 / 144

INDUSTRIAL

ATLAS

Polycarbonate lens with built-in sideshields maximize peripheral protection, ratchet temples with adjustable length to provide a secure, comfortable fit.

Lens Material: polycarbonate
Temples Material: polyamide



NEW



NEW

250-56-0020-EN

250-56-0015-EN

STYLE	LENS COLOR	FRAME/TEMPLE COLOR	LENS COATING	NOSE BRIDGE	BASE CURVE	WEIGHT	LENS MARKING	FRAME MARKING	EN NORM	PACKAGING
250-56-0020-EN	Clear	Blue	Anti-Scratch, Anti-Fog	Rubber	9,75	29,3 g	2C-1,2 P 1 FT CE	P EN166 FT CE	EN 166 / EN 170 / EN 172	12 / 144
250-56-0015-EN	IR Filter 5.0	Blue	Anti-Scratch, Anti-Fog	Rubber	9,75	29,3 g	4-5 P 1 FT CE	P EN166 FT CE	EN 166 / EN 170 / EN 172	12 / 144

Q-VISION

Flexible nose bridge for a comfortable fit, co-injected rubber temple ends provide excellent grip.

Lens Material: polycarbonate
Temples Material: polycarbonate/TPR



NEW



NEW

250-36-1020-EN

250-36-1021-EN

STYLE	LENS COLOR	FRAME/TEMPLE COLOR	LENS COATING	NOSE BRIDGE	BASE CURVE	WEIGHT	LENS MARKING	FRAME MARKING	EN NORM	PACKAGING
250-36-1020-EN	Clear	Black/Light green	Anti-Scratch, Anti-Fog	Rubber	10	28 g	2C-1,2 P 1 FT CE	P EN166 FT CE	EN 166 / EN 170 / EN 172	12 / 144
250-36-1021-EN	Gray	Black/Light green	Anti-Scratch, Anti-Fog	Rubber	10	28 g	5-3,1 P 1 FT CE	P EN166 FT CE	EN 166 / EN 170 / EN 172	12 / 144

NEPTUNE

Nylon frame allows lens ventilation, pivoting and adjustable length temples with rubber tips provide a comfortable fit.

Lens Material: polycarbonate
Temples Material: Nylon



250-57-1021-EN

STYLE	LENS COLOR	FRAME/TEMPLE COLOR	LENS COATING	NOSE BRIDGE	BASE CURVE	WEIGHT	LENS MARKING	FRAME MARKING	EN NORM	PACKAGING
250-57-1021-EN	Gray	HV Yellow	Anti-Scratch, Anti-Fog	TPR	9	28 g	5-3,1 P 1 FT CE	P EN166 FT CE	EN 166 / EN 170 / EN 172	12 / 144

INDUSTRIAL

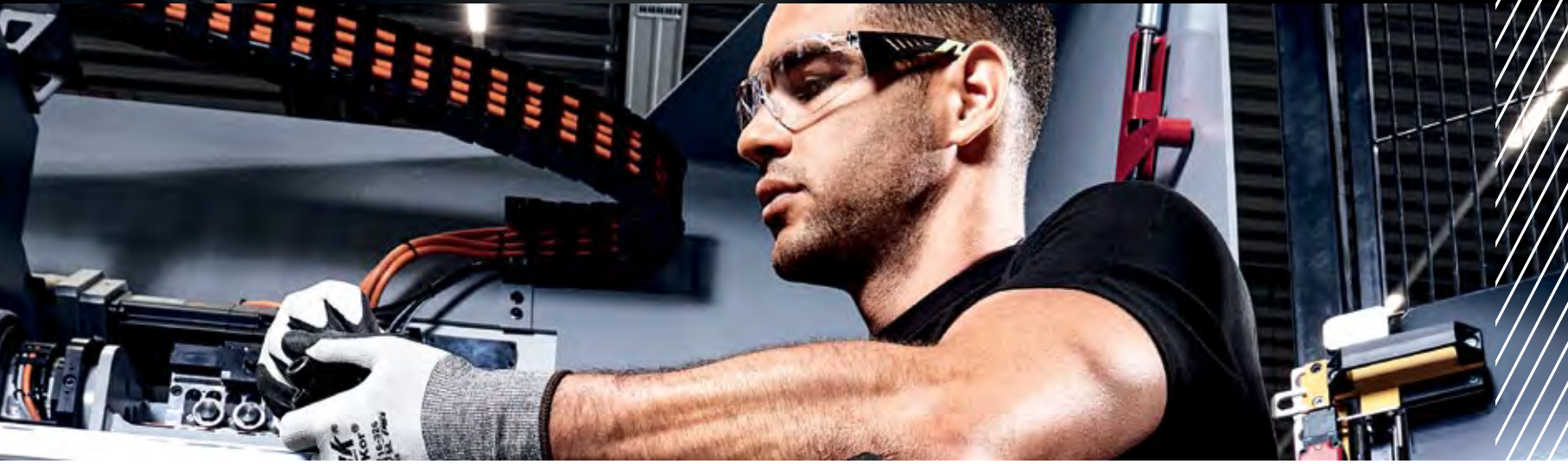

RECON

Lightweight, rimless design provides all day comfort, flexible bayonet temples contain rubber pads for a secure, non-slip fit.

Lens Material: polycarbonate
Temples Material: polycarbonate/PVC



NEW

250-32-0226-EN

Lens Technology



NEW

250-32-0021-EN



NEW

250-32-0020-EN



NEW

250-32-0010-EN

Lens Technology



STYLE	LENS COLOR	FRAME/TEMPLE COLOR	LENS COATING	NOSE BRIDGE	BASE CURVE	WEIGHT	LENS MARKING	FRAME MARKING	EN STANDARD	PACKAGING
250-32-0226-EN	I/O Blue	Brown	Anti-Scratch, Anti-Fog	Rubber	9	21,8 g	5-1.7 P 1 FT CE	P EN166 FT CE	EN 166 / EN 170 / EN 172	12 / 144
250-32-0021-EN	Gray	Dark Gray	Anti-Scratch, Anti-Fog	Rubber	9	21,8 g	5-3.1 P 1 FT CE	P EN166 FT CE	EN 166 / EN 170 / EN 172	12 / 144
250-32-0020-EN	Clear	Clear	Anti-Scratch, Anti-Fog	Rubber	9	21,8 g	2C-1.2 P 1 FT CE	P EN166 FT CE	EN 166 / EN 170 / EN 172	12 / 144
250-32-0010-EN	Clear	Clear	Anti-Scratch, Anti-Reflective	Rubber	9	21,8 g	2C-1.2 P 1 FT CE	P EN166 FT CE	EN 166 / EN 170 / EN 172	12 / 144

SEQUENCE

Lightweight, comfortable foam-sealed design keeps out dust & airborne particles, flexible co-injected temples provide a secure fit.

Lens Material: polycarbonate
Temples Material: polycarbonate/TPR



250-88-0120-EN



STYLE	LENS COLOR	FRAME/TEMPLE COLOR	LENS COATING	NOSE BRIDGE	BASE CURVE	WEIGHT	LENS MARKING	FRAME MARKING	EN STANDARD	PACKAGING
250-88-0120-EN	Clear	Black	Anti-Scratch, Anti-Fog	Molded	9	23 g	2C-1.2 P 1 FT CE	P EN166 FT CE	EN 166 / EN 170 / EN 172	12 / 144



bouton
BY PIP

EYE PROTECTION
CLASSIC

CLASSIC

Z12

Lightweight, rimless design provides all day user comfort, thin, flexible temples provide a secure fit without uncomfortable pressure points.

Lens Material: polycarbonate
Temples Material: polycarbonate



250-01-0900-EN



250-01-0001-EN

STYLE	LENS COLOR	FRAME/TEMPLE COLOR	LENS COATING	NOSE BRIDGE	BASE CURVE	WEIGHT	LENS MARKING	FRAME MARKING	EN STANDARD	PACKAGING
250-01-0900-EN	Clear	Clear	Anti-Scratch	Molded	9,5	24,0 g	2C-1,2 P 1 FT CE	P EN166 FT CE	EN 166 / EN 170 / EN 172	12 / 144
250-01-0001-EN	Gray	Black	Anti-Scratch	Molded	9,5	24,0 g	5-3,1 P 1 FT CE	P EN166 FT CE	EN 166 / EN 170 / EN 172	12 / 144

Z13

Flexible nose bridge for a comfortable fit, co-injected rubber temple ends provide excellent grip.

Lens Material: polycarbonate
Temples Material: polycarbonate / hydrogenated thermoplastic rubber



250-06-5501-EN



250-06-0000-EN

STYLE	LENS COLOR	FRAME/TEMPLE COLOR	LENS COATING	NOSE BRIDGE	BASE CURVE	WEIGHT	LENS MARKING	FRAME MARKING	EN STANDARD	PACKAGING
250-06-5501-EN	Gray	Dark Gray	Anti-Scratch	Molded	10	23,6 g	5-3,1 P 1 FT CE	P EN166 FT CE	EN 166 / EN 170 / EN 172	12 / 144
250-06-0000-EN	Clear	Clear	Anti-Scratch	Molded	10	23,6 g	2C-1,2 P 1 FT CE	P EN166 FT CE	EN 166 / EN 170 / EN 172	12 / 144

SPARK

Polycarbonate lens with built-in sideshields maximize peripheral protection, adjustable length temples provide a secure, comfortable fit.

Lens Material: polycarbonate
Temples Material: polyamide



250-24-0000-EN



250-24-0080-EN

STYLE	LENS COLOR	FRAME/TEMPLE COLOR	LENS COATING	NOSE BRIDGE	BASE CURVE	WEIGHT	LENS MARKING	FRAME MARKING	EN STANDARD	PACKAGING
250-24-0000-EN	Clear	Black	Anti-Scratch	Molded	4	32,8 g	2C-1,2 P 1 FT CE	P EN166 FT CE	EN 166 / EN 170 / EN 172	12 / 144
250-24-0080-EN	Clear	Black	Uncoated	Molded	4	32,8 g	2C-1,2 P 1 FT CE	P EN166 FT CE	EN 166 / EN 170 / EN 172	12 / 144

GOGGLES

VOLANS

Tough clear polycarbonate lens for high-impact protection, adjustable elastic strap provides a comfortable fit.

Lens Material: polycarbonate



251-60-000V-EN | TAURUS (visor VOLANS)

Can be attached and removed from goggle in seconds

251-60-0020-EN

STYLE	LENS COLOR	FRAME/TEMPLE COLOR	LENS COATING	NOSE BRIDGE	BASE CURVE	WEIGHT	LENS MARKING	FRAME MARKING	EN STANDARD	PACKAGING
251-60-0020-EN	Clear	Clear	Anti-Scratch, Anti-Fog	Rubber	5	11,3 g	2C-1.2 P 1 BT CE	P EN 166 3 BT CE	EN 166 / EN 170 / EN 172	5 / 60
251-60-000V-EN	Clear					62 g		P EN166 FT CE	EN 166 / EN 170 / EN 172	4 / 4

MISSION

Indirect vent for liquid splash protection, adjustable elastic strap provides a comfortable fit.

Lens Material: polycarbonate



251-63-0520-EN

STYLE	LENS COLOR	FRAME/TEMPLE COLOR	LENS COATING	NOSE BRIDGE	BASE CURVE	WEIGHT	LENS MARKING	FRAME MARKING	EN STANDARD	PACKAGING
251-63-0520-EN	Clear	Clear	Anti-Scratch K, Anti-Fog N	Rubber	6	124 g	2C-1.2 P 1 BT KN CE	P EN166 3 4 BT CE	EN 166 / EN 170 / EN 172	5 / 60

FORTIS 2

Offers indirect ventilation for liquid splash protection, fits comfortably over most prescription glasses.

Lens Material: polycarbonate



251-80-0020-EN

STYLE	LENS COLOR	FRAME/TEMPLE COLOR	LENS COATING	NOSE BRIDGE	BASE CURVE	WEIGHT	LENS MARKING	FRAME MARKING	EN STANDARD	PACKAGING
251-80-0020-EN	Clear	Clear	Anti-Scratch, Anti-Fog	Rubber	5	83,4 g	2C-1.2 P 1 9 BT CE	P EN166 3 9 BT CE	EN 166 / EN 170 / EN 172	6 / 72

GOGGLES

TRITON

Wide facial flange for a secure seal, flexible, soft rubber/polyester body for optimal comfort and fit, fits comfortably over most prescription glasses.

Lens Material: polycarbonate



NEW

251-54-0020-EN

STYLE	LENS COLOR	FRAME/TEMPLE COLOR	LENS COATING	NOSE BRIDGE	BASE CURVE	WEIGHT	LENS MARKING	FRAME MARKING	EN NORM	PACKAGING
251-54-0020-EN	Clear	Clear	Clear	Anti-Scratch	Rubber	6	59 g	P EN 166 3 9 BT CE	EN166 / EN170 / EN172	10 / 120

BASIC

The economical solution to your safety goggle needs. Ideal for general manufacturing & anywhere eye protection is needed.

Lens Material: polycarbonate



248-4400-300-EN

STYLE	LENS COLOR	FRAME/TEMPLE COLOR	NOSE BRIDGE	WEIGHT	LENS MARKING	FRAME MARKING	EN NORM	PACKAGING
248-4400-300-EN	Clear	Clear	Rubber	12 g	P 1 B 9 CE	P EN 166 4 9 B CE	EN 166 / EN 170 / EN 172	12 / 144



SOLAR



BOND

Classic keyhole bridge design improves comfort and fit, frame contains no metal parts.

Lens Material: polycarbonate
Temples Material: Nylon



250-89-0004-EN

Lens Technology



250-89-0008-EN

Lens Technology



250-89-0021-EN

STYLE	LENS COLOR	FRAME/TEMPLE COLOR	LENS COATING	NOSE BRIDGE	BASE CURVE	WEIGHT	LENS MARKING	FRAME MARKING	EN STANDARD	PACKAGING
250-89-0004-EN	Red Mirror Plus Technology	Translucent Charcoal	Anti-Scratch, Anti-Reflective	Molded	8	30,65 g	5-3.1 P 1 F CE	P EN166 FT CE	EN 166 / EN 170 / EN 172	6 / 72
250-89-0008-EN	Green Mirror Plus Technology	Translucent Charcoal	Anti-Scratch, Anti-Reflective	Molded	8	30,65 g	5-3.1 P 1 F CE	P EN166 FT CE	EN 166 / EN 170 / EN 172	6 / 72
250-89-0021-EN	Gray	Translucent Charcoal	Anti-Scratch, Anti-Fog	Molded	8	30,65 g	5-3.1 P 1 F CE	P EN166 FT CE	EN 166 / EN 170 / EN 172	6 / 72

SUNBURST

Lightweight, full frame design offers all day comfort, Bayonet temples are rubber co-molded for a secure fit.

Lens Material: polycarbonate
Temples Material: polycarbonate / TPR



250-47-0021-EN

STYLE	LENS COLOR	FRAME/TEMPLE COLOR	LENS COATING	NOSE BRIDGE	BASE CURVE	WEIGHT	LENS MARKING	FRAME MARKING	EN STANDARD	PACKAGING
250-47-0021-EN	Gray	Black	Anti-Scratch, Anti-Fog	Rubber	8	30 g	5-3.1 P 1 FT CE	P EN166 FT CE	EN 166 / EN 170 / EN 172	6 / 72

OTG

AEGEAN

Lightweight OTG safety glasses with soft nose pads and soft component padded adjustable ratchet temples.

Lens Material: polycarbonate

Temples Material: polycarbonate, thermoplastic rubber



250-66-0020-EN

SCOUT

Over-the-glass design fits over all prescription eyewear, can also be worn by itself as a regular safety glass.

Lens Material: polycarbonate

Temples Material: polycarbonate



250-99-0920-EN

STYLE	LENS COLOR	FRAME/TEMPLE COLOR	LENS COATING	NOSE BRIDGE	BASE CURVE	WEIGHT	LENS MARKING	FRAME MARKING	EN STANDARD	PACKAGING
250-66-0020-EN	Clear	Black/Blue	Anti-Scratch, Anti-Fog	Rubber	3	39,8 g	2C-1,2 P 1 FT CE	P EN166 FT CE	EN 166 / EN 170 / EN 172	10 / 120
250-99-0920-EN	Clear	Clear	Uncoated	Molded	4	38 g	2C-1,2 P 1 FT CE	P EN166 FT CE	EN 166 / EN 170 / EN 172	12 / 144

VISOR

HYDRA

Ratchet suspension provides effortless size adjustment, lightweight and durable blue polypropylene.



251-01-5400-EN

N.B.: Stand only
Pegasus visor not included

PEGASUS

Aspherical shape is tapered at the chin for improved head/neck range of motion, universal hole pattern will fit most headgear and hard hat adapters in the market.

Lens Material: polycarbonate



251-01-7401-EN

STYLE	LENS COLOR	FRAME/TEMPLE COLOR	LENS COATING	WEIGHT	FRAME MARKING	EN STANDARD	PACKAGING
251-01-5400-EN		Blue		183 g	EN 166 BT CE	EN 166 / EN 170 / EN 172	1 / 10
251-01-7401-EN	Clear	Black/Gray	Uncoated	186 g	P 1 BT CE	EN 166 / EN 170 / EN 172	10 / 40

ACCESSOIRES



NEW

252-LCT100-EN
LENS CLEANING TOWELETTES

Anti-fog, anti-static, anti-scratch formula, the dispenser can be easily placed on a wall.



NEW

252-LCS08-EN
LENS CLEANING STATION

Lint-free absorbent tissues are made from 100% recycled materials, station can also be easily placed on walls.



NEW

252-C001-EN
GLASSES CASE

This semi-rigid case with zip closure offers a high protection to safety glasses when they are not worn.



NEW

252-MFP01-EN
LENS POUCH

Protects the spectacles/goggles when not in use.



NEW

252-L401-EN
EYEWEAR CORD

Keeps glasses close at hand for a safer workplace.



NEW

252-L407-EN
ELASTIC EYEWEAR CORD

Keeps glasses close at hand for a safer workplace.

STYLE	COLOR	WEIGHT	PACKAGING
252-LCT100-EN	/	/	1 / 10
252-LCS08-EN	/	/	1 / 8
252-C001-EN	Black	/	1 / 100

STYLE	COLOR	WEIGHT	PACKAGING
252-MFP01-EN	Black	/	12 / 144
252-L401-EN	Black	2,90 g	12 / 420
252-L407-EN	Black	/	12 / 144

DISPLAY YOUR GLASSES Bouton®



DISPLAY 9 Bouton® GLASSES

CODE	DESCRIPTION
251-DS-0009	Made of metal and plastic. For 9 glasses. Packaging: 1 / 6 (Items not included)



DISPLAY 5 Bouton® GLASSES

CODE	DESCRIPTION
900800	Made of transparent Plexiglas with mirror. For 5 glasses. (Items not included) Packaging: 1 pz. (Items not included)

PIP

HEARING PROTECTION
EAR PLUGS

PIP
00110

HEARING PROTECTION

UNDERSTANDING EN PERFORMANCE MARKINGS

SNR

The SNR is the "Simplified Noise Level Reduction" or "Single Number Rating" which is the simplest way of getting a general indication for the level of protection provided. It is generally used to compare different types of hearing protectors. In very simple terms the calculation would be:

Noise Level 100 dB

Hearing Protector SNR -30 dB

Noise Reaching Ear 70 dB

The noise reaching the wearer should not exceed 87 dB and preferably lie between 70 - 80 dB. This calculation does not take into account different frequencies so may not be the most suitable measurement.

dB (decibel)

dB (decibel) is used to measure the sound intensity. Because the human ear can register sounds across a huge range of intensities a linear scale is not suitable for measurement. The dB scale is therefore a log scale which in very simple terms means the sound intensity roughly doubles for every 3 dB increase. An increase of 20 dB would increase the sound intensity 100 times, (ie 60 dB is 100 times louder than 40 dB).

Protection should ideally limit exposure to between 70 - 80 dB at the ear and not exceed 87 dB. However it is also important not to over protect as the wearer may not be able to hear other sounds such as fire alarms or vehicles. The user may also feel isolated resulting in reluctance to wear the hearing protection when needed. It is, therefore, best not to implement a blanket wearing of hearing protection only specifying protection where it is actually required.

CHOOSING THE CORRECT PROTECTION

The key to achieving optimal protection is selecting the ear plug size, shape and style suitable for each worker.



BULLET™

Fits to the natural contour of the ear canal.



FLARE™

Wide base seals out dirt and debris.



T-FIT™

Designed for easy handling, fit and long term wear.



SoftStar™

Classic cylinder design is a proven favorite for many workers.



EZ-Twist™

Combines comfort with convenience, hygiene and ease-of-use.

COMMON APPLICABLE STANDARDS

Standard	Detail
EN 352-1	For Ear Muffs
EN 352-2	For Ear Plugs
EN 352-3	For Helmet Mounted Ear Muffs

SELECTING APPROPRIATE PROTECTION

How To Decide On Protection Levels - A Simple Guide

The best way to decide on whether or not protection is needed is to arrange a specialist survey from an independent professional. If an employee needs to raise their voice to be heard a few feet away then the noise levels may be over 85 dB and immediate action should be taken.

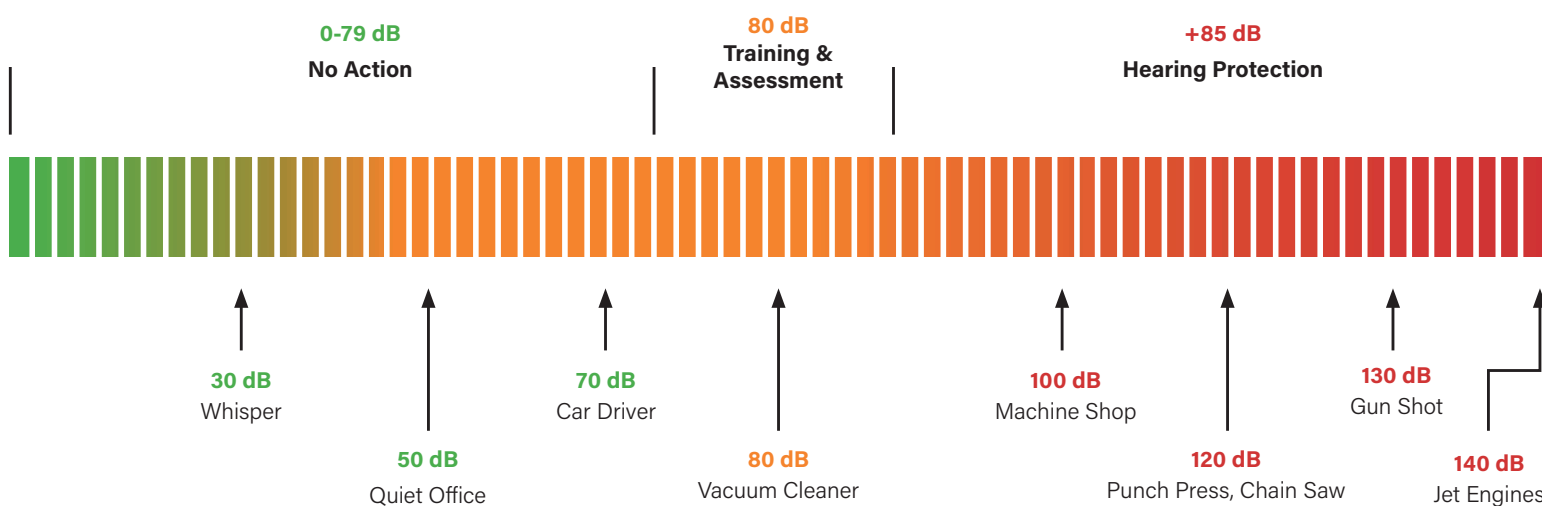

PowerSoft™ FOAM TECHNOLOGY

Getting a proper fit

Foams with small, dense cells may result in:

- > harder plugs with shorter rebound time
- > more pressure and discomfort in ear canal

Foams with large, airy cells may result in:

- > uneven roll-down and longer time to fit
- > Longer rebound time

PIP® EAR PLUGS WITH POWERSOFT™
FOAM TECHNOLOGY DELIVER:

- > OPTIMAL REBOUND
- > MAXIMUM ALL-DAY COMFORT & PERFECT FIT



SINGLE-USE POWERSOFT™ TECHNOLOGIE | TECHNOLOGY

Soft & comfortable conical shape earplugs. Easy to shape for quick & easy insertion.



MEGA BULLET™

- Regular size fits most ear canals
- Easy roll-down for quick and easy insertion
- PowerSoft™ Foam Technology features a proprietary polyurethane formulation that delivers optimal recovery time, easy insertion and maximum all-day comfort
- Shape conforms to most ear canals for maximum sound attenuation
- Traceable metal detectable (Blue) style available for use in the food industry

Shape suitable for smaller ear canals. Easy to shape for quick and easy insertion.



NANO BULLET™

- Designed to accommodate smaller ear canals
- Easy roll-down for quick and easy insertion
- Non-irritating smooth outer surface
- PowerSoft™ Foam Technology features a proprietary polyurethane formulation that delivers optimal recovery time, easy insertion and maximum all-day comfort

Facilitated removal due to "T" shape. Easy to shape for quick & easy insertion.



MEGA T-FIT™

- Wide base allows easier insertion and removal
- Design resists backing out of ear
- PowerSoft™ Foam Technology features a proprietary polyurethane formulation that delivers optimal recovery time, easy insertion & maximum all-day comfort
- Shape conforms to most ear canals for maximum sound attenuation



267-HPD210/250-EN
CAP DISPENSER



267-HPF210-1-EN
REFILL PACK

STYLE	EN STANDARD	SNR	H	M	L	DIAMETER	CORDING	METAL DETECTABLE	SHAPE	COLOR	QUANTITY / BOX (PAIRS)
267-HPF210-EN	EN 352-2	38	37	35	33	5 - 11 mm	Yes	No	Cylindrical	Orange	200 / 2000
267-HPF210C-EN	EN 352-2	38	37	35	33	5 - 11 mm	Yes	No	Cylindrical	Orange	100 / 1000
267-HPF210-1-EN	EN 352-2	38	37	35	33	5 - 11 mm	No	No	Cylindrical	Orange	250 / 5000
267-HPF310-EN	EN 352-2	37	37	34	31	5 - 9 mm	No	No	Cylindrical	Viola	200 / 2000
267-HPF510-EN	EN 352-2	37	37	34	32	5 - 10 mm	No	No	T	Orange	200 / 2000
267-HPD210/250*							No	No	/	Black	1 / 4

No need to model before wearing. Ideal for use with dirty hands or with gloves.



267-HPF610-EN

EZ-TWIST™

- No need to roll down before fitting, ideal for use with dirty hands
- PowerSoft™ Foam Technology features a proprietary polyurethane formulation that delivers optimal recovery time, easy insertion & maximum all-day comfort
- Shape conforms to most ear canals for maximum sound attenuation
- Traceable metal detectable (blue) style available for use in the food industry

Most comfortable & soft cylindrical earplugs. Easy to shape for quick & easy insertion.



267-HPF710-EN

SOFTSTAR™

- Unique beveled edge helps insertion
 - PVC*-free PowerSoft™ Foam polyurethane foam
 - PowerSoft™ Foam Technology features a proprietary polyurethane formulation that delivers optimal recovery time, easy insertion and maximum all-day comfort
 - Shape conforms to most ear canals for maximum sound attenuation
- * Most PVC formulations are listed as under Prop 65 as a controlled material

DETECTABLE EAR PLUGS



NEW

267-HPF210D-EN

Soft & comfortable conical shape earplugs. Easy to shape for quick and easy insertion.

MEGA BULLET™

- Regular size fits most ear canals
- Easy roll-down for quick and easy insertion
- PowerSoft™ Foam Technology features a proprietary polyurethane formulation that delivers optimal recovery time, easy insertion and maximum all-day comfort
- Shape conforms to most ear canals for maximum sound attenuation
- For use in the food industry
- Both ear plugs and cord are detectable.

REUSABLE

Self-sealing flanges give all day comfort. Can be reused several times, making them very cost efficient.



NEW

267-HPR400C-EN

including the boxolin

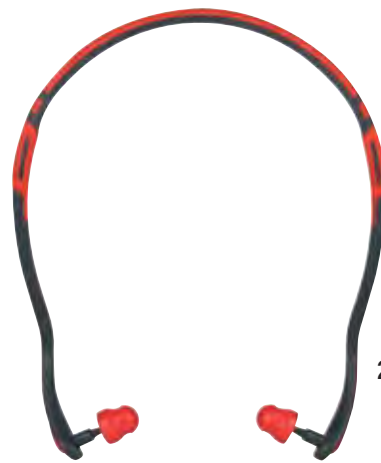

NEW

267-HPB410-EN

4-FLANGE REUSABLE

- Pre-formed plug shape with no rolling required makes insertion simple
- Reusable several times, they can be cleaned with soap and water
- Self-sealing flanges give all day comfort
- Rigid stem makes insertion easy and reduces the risk of contamination
- Can be reused several times, making them very cost efficient

POLYPROPYLENE BANDED FOAM EAR PLUGS

Foam plug fits the shape of the ear canal opening snugly, for stability, comfort and improved sound attenuation. Pair of replacement plugs included.

STYLE	EN STANDARD	SNR	H	M	L	DIAMETER	CORDING	METAL DETECTABLE	HAPE	COLOR	QUANTITY / BOX (PAIRS)
267-HPF610-EN	EN 352-2	38	38	36	34	7 - 13 mm	No	No	Cylindrical with pin	Orange	200 / 2000
267-HPF710-EN	EN 352-2	36	37	33	29	5 - 11 mm	No	No	Cylindrical	Red	200 / 2000
267-HPF210D-EN	EN 352-2	38	37	35	33	5 - 11 mm	Yes	Yes	Cylindrical	Blue	100 / 1000
267-HPR400C-EN	EN 352-2	33	33	31	29	8 - 10 mm	Yes	No	4-flange conical	Orange	50 / 500
267-HPB410-EN	EN 352	32	33	29	28				conical	Red-Gray	10 / 100

PIP

BioSoft[™]

SUSTAINABLE BIO-BASED TECHNOLOGY

BIOSOFT[™] EAR PLUGS

THE WORLD'S FIRST
SUSTAINABLE BIO-BASED
EAR PLUGS



GREEN HEART[®]

THE WORLD'S FIRST SUSTAINABLE BIO-BASED EAR PLUGS

PIP® understands the importance of reducing waste to lower costs and minimize environmental impact.

Our new, sustainable Green Heart® BioSoft™ ear plugs are the first to be made from bio-based technologies.

BioSoft™

SUSTAINABLE BIO-BASED TECHNOLOGY

The BioSoft™ ear plug foam material provides the same fit and performance as conventional polyurethane or PVC materials, but with a lower carbon footprint.

This innovative technology not only reduces emissions during manufacturing, but it contains bio-based materials making BioSoft™ more environmentally friendly at end of use.

CARBON FOOTPRINT COMPARISON

Equivalent CO₂ Emissions per 10,000 pairs of foam disposable ear plugs.



VS.

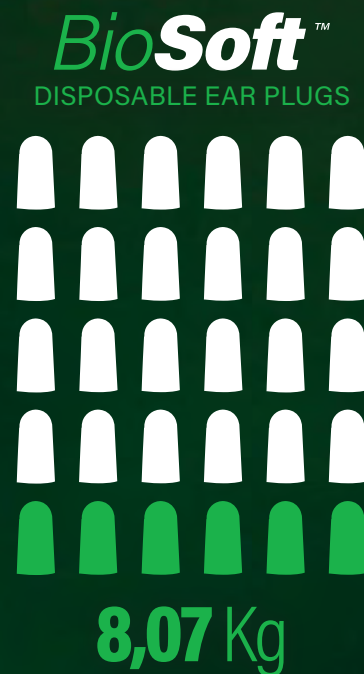

BIOSOFT™ FOAM EAR PLUGS
REDUCE CO₂ EMISSIONS BY OVER 82%
COMPARED WITH TRADITIONAL POLYURETHANE FOAM EARPLUGS.

MEGA BULLET™ BIOSOFT

NEW

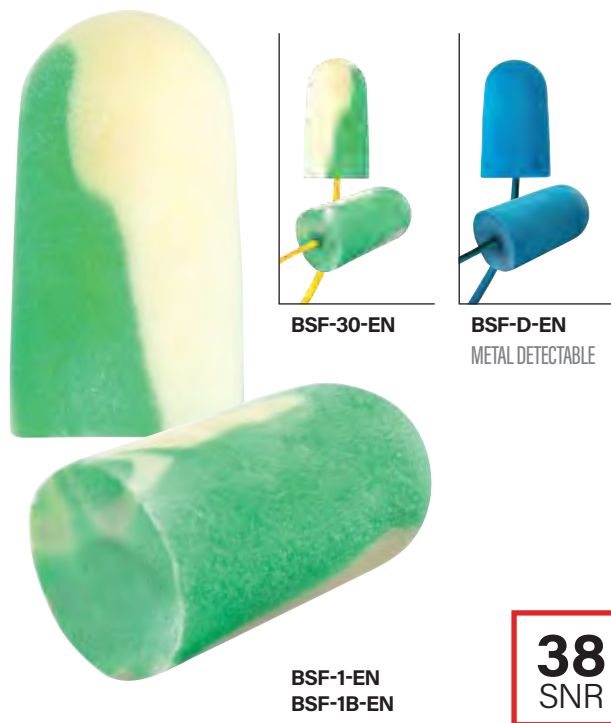

BSF-1-EN
BSF-1B-EN

BSF-D-EN
METAL DETECTABLE

38
SNR

Tapered shape for easy installation

- Soft, smooth, low pressure for excellent comfort
- Bio-based materials made in North America
- Independently tested SNR 38
- Metal detectable (blue) recommended for use in the food industry.

ATTENUATION CHART (Tested according to EN352-2:2020)

FREQUENCY (Hz)	125	250	500	1000	2000	3150	4000	6300	8000
MEAN ATTENUATION (dB)	40.3	39.8	41.9	40.6	39.7	45.1	46.6	47.8	47.2
STANDARD DEVIATION (dB)	5.5	5.4	5.8	3.8	2.6	4.1	3.7	3.5	4.5

	BSF-1-EN	BSF-1B-EN	BSF-30-EN	BSF-D-EN
USE	Single	Single	Single	Single
LANYARD	Uncorded	Uncorded	Corded	Corded
MATERIAL	BioSoft™ Foam	BioSoft™ Foam	BioSoft™ Foam	BioSoft™ Foam
SIZE	Standard	Standard	Standard	Standard
SHAPE	Bullet	Bullet	Bullet	Bullet
COLOR	Green/White	Green/White	Green/White	Blue
DETECTABLE	No	No	No	Yes
PAIRS PER BOX	200	500	100	100
PACKAGE	10 X 200	4 X 500	10 X 100	10 X 100

PINCH FIT™ BIOSOFT

NEW



PF-30-EN

PF-D-EN
METAL DETECTABLE

PF-1-EN

38
SNR

Unique stem enables easy insertion

- Revolutionary design requires no rolling and provides an easier, more hygienic fit
- Bio-based materials made in North America
- All parts—the earplug, the cord (PF-30 only), the stem, even the bag are bio-based
- Soft, smooth, low pressure for excellent comfort
- Metal detectable (blue) recommended for use in the food industry.

ATTENUATION CHART (Tested according to EN352-2:2020)

FREQUENCY (Hz)	125	250	500	1000	2000	3150	4000	6300	8000
MEAN ATTENUATION (dB)	39.3	37.8	42.9	40.6	39.1	44.4	46	47.8	46.2
STANDARD DEVIATION (dB)	5.5	5.4	5.8	3.8	2.6	4.1	3.7	3.5	4.5

	PF-1-EN	PF-30-EN	PF-D-EN
USE	Single	Single	Single
LANYARD	Uncorded	Corded	Corded
MATERIAL	BioSoft™ Foam	BioSoft™ Foam	BioSoft™ Foam
SIZE	Standard	Standard	Standard
SHAPE	Push-In	Push-In	Push-In
COLOR	Yellow/Orange	Yellow/Orange	Blue
DETECTABLE	No	No	Yes
PAIRS PER BOX	100	100	100
PACKAGE	10 X 100	10 X 100	10 X 100



THE WORLD'S FIRST SUSTAINABLE BIO-BASED EAR PLUG

BioSoft™
SUSTAINABLE BIO-BASED TECHNOLOGY

BEGINNING OF LIFE

> Made from 82% bio-based materials



REPLENISHABLE SOURCE



SUSTAINABLE MATERIAL



CO₂ EMISSION REDUCTION



IN USE

> Without sacrificing performance or comfort.

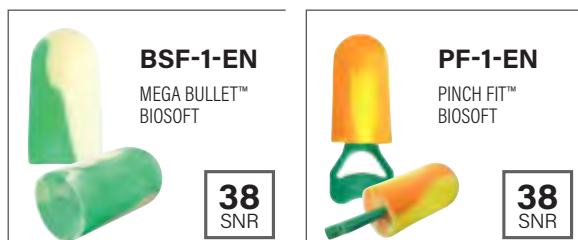

MATERIAL	BioSoft™ BIO-BASED FOAM	PU or PVC
SHELF LIFE	SAME	SAME
SLOW RECOVERY FOAM	✓	✓
BIO-BASED PACKAGING	✓	

END OF LIFE

> BioSoft™ ear plugs will decompose 76% in 180 days*. Traditional PU or PVC ear plugs will remain unchanged.



* When tested in accordance with EN 13432 – in an aerobic environment (air/oxygen present)

COMMITMENT TO SUSTAINABILITY

As a global provider of PPE, PIP® is committed to continually identifying opportunities to minimize our environmental footprint to support a more sustainable, safer future. We are focused on leading the way, along with our industrial distributors, by offering products and solutions that minimize our impact while maximizing protection against occupational hazards.



PROTECTIVE INDUSTRIAL PRODUCTS
www.pipeurope.com

A woman with reddish-brown hair tied back is shown in profile, wearing a black t-shirt, safety glasses, and large black ear muffs. She is looking down at a piece of industrial machinery. The background is a factory setting with various metal parts and equipment. The PIP logo is visible in the top left corner.

PIP

PIP
FRANCE
L'HERMENAULT
CE 2777
EN352
CLASSIC

HEARING PROTECTION
EAR MUFFS

EAR MUFFS



CLASSIC
263-NP220

Very light and adjustable earmuffs. Dielectric / non-conductive design. SNR: 29dB



ELEVATE I
263-NP221

Minimum pressure on the top of the head thanks to its adjustable headband. Foldable earmuffs for easy transport. SNR: 27dB



ELEVATE II
263-NP222

Sliding height adjustable headband for greater comfort. Soft and wide cushions fit comfortably around the ears. SNR: 28dB

STYLE	EN STANDARD	SNR	H	M	L	MATERIAL	PESO	COLOR	PACKAGING
263-NP220	EN 352-1	29	34	26	19	ARC: thermoplastique POM - CUPS: PP / PVC leather / PU foa	157g	Black/Silver	1 / 25
263-NP221	EN 352-1	27	29	25	17	HEADBAND: NEOPRENE / LEATHER PU - ARC: CARBON STEEL - CUPS: ABS NYLON / PU FOAM	247g	Black/Silver	1 / 20
263-NP222	EN 352-1	28	32	26	17	HEADBAND: NEOPRENE / LEATHER PU - ARC: CARBON STEEL - CUPS: ABS NYLON / PU FOAM	215g	Black/Silver	1 / 20

ECO-FRIENDLY



GREEN HEART®

ELEVATE GH

The Elevate GH protective earmuffs offer an impressive combination of high levels of protection combined with a sustainable vision. More than 50% of the weight is made up of recycled materials. Earmuffs with length adjustment, easily adjustable for a perfect fit. Extra soft memory foam to guarantee a premium comfort for a long use time. Soft surfaces and padded headband for optimal comfort.

NEW
SNR: 27



ELEVATE GH III
263-NP330-EN

59% of the weight is made up of recycled materials. SNR: 27dB

NEW
SNR: 32



ELEVATE GH IV
263-NP331-EN

66% of the weight is made up of recycled materials. SNR: 32dB

NEW
SNR: 37



ELEVATE GH V
263-NP332-EN

54% of the weight is made up of recycled materials. SNR: 37dB

STYLE	EN STANDARD	SNR	H	M	L	MATERIAL	WEIGHT	COLOR	PACKAGING
263-NP330-EN	EN 352-1	27	28	25	18	HEADBAND: PVC AND FABRIC	200,49 g	Black/Silver	1 / 20
263-NP331-EN	EN 352-1	32	36	30	23	ARC: CARBON STEEL	278,93 g	Black/Silver	1 / 20
263-NP332-EN	EN 352-1	37	39	35	27	CUPS, BUCKLES, RINGS: RECYCLED ABS, PVC & PE FOAM	338,93 g	Black/Silver	1 / 20

BASE LAYER HEATED VEST

300-HV100

REVOLUTIONARY HEATING TECHNOLOGY.

Designed to warm and maintain body temperature in order to sustainably combat winter conditions. Breathable softshell material provides an ideal base layer for lightweight warmth, comfort and versatility. The lightweight, one-size-fits-all, dynamic-fit jacket is equipped with durable, double-locking Velcro straps. Three heat settings available using the illuminated LED button on the jacket, or the convenient included remote control.

Effective heat for 4 hours on a single charge Easy to take care of, machine washable with 50+ wash cycles*

RECHARGEABLE BATTERY 5V/2A



- Multi-level safety system provides protection against short circuits
- Replacement battery: 399-HVBAT

DYNAMIC ADJUSTMENT

- Easy to adjust, double locking velcro ensures a secure and comfortable fit

RECHARGEABLE BATTERY 5V/2A



- Control 3 heat levels with the included wireless remote
- Replacement remote: 399-HVRE Chaleur



EVAPORATIVE COOLING TOWEL

396-EZ900

Provides UV protection and resists odors. Quickly reduces temperature when soaked in water and activated to provide cooling effect



STYLE	DESCRIPTION	BATTERY	FABRIC	SIZE	PACKAGING
300-HV100	Heated vest		Nylon	One size	1 / 12
399-HVBAT	Heated vest spare battery	5V/2A			1 / 60
399-HVRE	Heated vest remote controller				1 / 50
396-EZ900	Cooling towel		55% nylon / 45% polyester		1 / 48



Fall protection

Featured Security

Welcome to the world of Akrobat, the line of fall protection products owned by Industrial Starter S.p.A. by PIP. In an industry where occupational safety is a priority, Akrobat stands as the reliable line for all industry professionals.

Akrobat's Mission: Safety First.

In an environment where every detail counts, our mission is to ensure maximum protection for those who work at height. Fall-related accidents pose a serious threat, but with Akrobat, you face your work with the confidence that you are properly equipped.

Our Range: The Security You Need

Explore our comprehensive catalog of products, each designed with the utmost care to ensure safety and comfort. From safety harnesses to positioning belts, karabiners to innovative retractable devices and EN795-B temporary lifelines, Akrobat offers complete solutions for every fall protection-related need.

Innovation and Certification: Our Promise of Quality

Akrobat is synonymous with innovation and reliability. Each product is the result of advanced technologies and state-of-the-art production methods, ensuring compliance with the strictest safety regulations. Compliance with EN standards, combined with certified quality, positions Akrobat as the benchmark brand for construction site safety.

Protecting Life, Every Day: The Heart of Akrobat

Every worker has the right to return home safely every day. Akrobat is committed to making this vision a reality. We invite industry professionals to embrace the culture of safety by adopting our products as indispensable allies in the fight against fall hazards.

Choose Akrobat: your trusted companion for security in every work setting. Protect life, protect the future.

Note: The certification values shown in this catalogue may vary due to the continuous updating process; for exact data, please ask for updated technical data sheet.





BEFORE USE.

Read the manual supplied with the harness carefully. Check the date of manufacture and that the sling does not has expired, by checking the inspection logbook that no more than one year has passed since the last inspection (or since the last time the date of commissioning). Check the wear condition.





Some examples of use

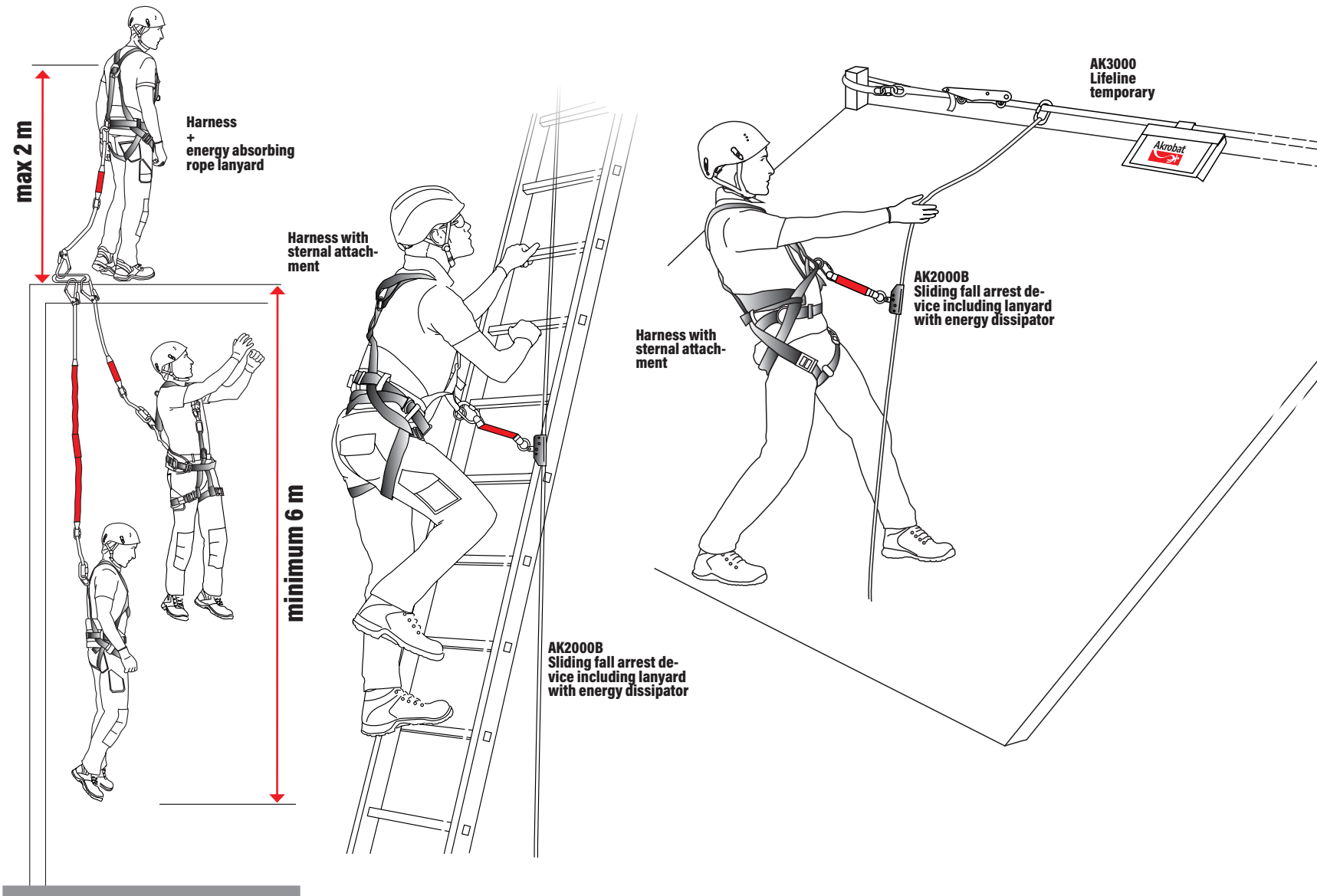



Harness STANDARD

Maintains all the essential technical features of its "big sister" product, AKROBAT PLUS, and meets all regulations; only a few accessories are removed. It would therefore be a mistake to consider it a budget product line; it should be understood as an "essential" range suitable for those who will use it infrequently, or who are happy to give up the extra level of comfort (but not safety) in return for a cost saving.



**tested
136 Kg**

- All Akrobat harnesses are certified 100 kg. as the EN361 standard only provides for this type of verification but in truth they are all tested up to 136 kg.



AK002
HARNES AKROBAT
EN361
Anchorage point:
back
Full box: 20 pcs.



AK003
HARNES AKROBAT
EN361
Anchorage point:
back and chest
Full box: 20 pcs.



AK005
HARNES AKROBAT
EN361 - EN358
Anchorage point:
back and chest + positioning belt
Full box: 10 pcs.



Harness PLUS

Recommended for professionals who require a full range of accessories for increased comfort in addition to the essential safety features.

NB: harnesses packaged individually in boxes or blister packs for in-store display purposes.

tested
136 Kg

- All Akrobat harnesses are certified 100 kg, as the EN361 standard only provides for this type of verification but in truth they are all tested up to 136 kg.



Larger positioning belt (if included) and mobile phone holder.



Double adjustable belt for a better fit.



Buckle extension and dorsal brace for greater ease of use



Carabiner for sternal attachment



FALL INDICATOR: indicates when the harness has "worked", absorbing such a force that the replacement of the harness is recommended (as it may have partly lost its efficiency).



Packaging

AK20 HARNES AKROBAT PLUS EN361

Anchorage point:
back

Accessories: double adjustment, mobile pocket, sit strap, back extension band. Packed in blister.

Full box: 5 pcs.



AK30 HARNES AKROBAT PLUS EN361

Anchorage point:
back and chest

Accessories: double adjustment, carabiner, mobile pocket, sit strap, back extension band. Packed in blister.

Full box: 5 pcs.



AK50 HARNES AKROBAT PLUS EN361 - EN358

Anchorage point:
back and chest

Accessories: double adjustment, carabiner, mobile pocket, sit strap, large positioning belt, back extension band. Packed in box.

Full box: 5 pcs.



AK60 HARNES AKROBAT PLUS HARNES TOP VERSION EN361 - EN358 - EN813

Anchorage point:
back, chest and at waist

Accessories: double adjustment, carabiner, mobile pocket, sit strap, large positioning belt, back extension band. Packed in box.

Accessories TOP version: padding on back, shoulders and sit strap.

Full box: 5 pcs.





Harness STRETCH

Similar to the AKROBAT PLUS line, but with high tenacity stretch fabric straps. Another step forward in AKROBAT's technical evolution, in line with requests from our most demanding users, who keep up with the latest developments. The end result is to improve comfort without noticeably increasing the cost of the product. The harness' main features are indicated in the illustrated details.

tested
136 Kg

- All Akrobat harnesses are certified 100 kg. as the EN361 standard only provides for this type of verification but in truth they are all tested up to 136 kg.



FALL INDICATOR: indicates when the harness has "worked", absorbing such a force that the replacement of the harness is recommended (as it may have partly lost its efficiency).



STRETCH: stretch fabric makes the model even more comfortable and ergonomic.



Mobile phone holder



Double adjustment:
To better fit the belt to the body.



Buckle extension
and dorsal brace for greater ease of use



Sit strap



AK25 HARNES STRETCH EN361

Stretch harness for the best comfort.
Anchorage point: back
Accessories: double adjustment, mobile pocket, sit strap, back extension band. Fall indicator.
Full box: 5 pcs.



+Size
XXL

AK35 HARNES STRETCH EN361 - EN 358

Stretch harness for the best comfort.
Anchorage point: back and chest
Accessories: double adjustment, mobile pocket, sit strap, back extension band. Fall indicator.
Sizes: L= regular or XXL= maxi
Full box: 5 pcs.



POSITIONING BELT:
LARGER SIZES



+Size
XXL



AK55 HARNES STRETCH EN361 - EN358

Stretch harness for the best comfort. Supplied with positioning belt.
Anchorage point: back and chest
Accessories: double adjustment, carabiner, mobile pocket, sit strap, back extension band. Fall indicator
Sizes: L= regular or XXL= maxi
Full box: 5 pcs.





Harness EXCLUSIVE STRETCH

Another step forward in AKROBAT's technical evolution, in line with requests from our most demanding users, who keep up with the latest developments. The harness' main strengths as well as its unparalleled comfort are indicated in the illustrated details.

tested
136 Kg

- All Akrobat harnesses are certified 100 kg, as the EN361 standard only provides for this type of verification but in truth they are all tested up to 136 kg.



Automatic buckle: can be unfastened under load, extremely easy to use and adjust with one hand but with dual controls. Produced with high quality steel which is corrosion-resistant, convenient and comfortable to wear.

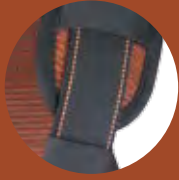

STRETCH: stretch fabric makes the model even more comfortable and ergonomic.

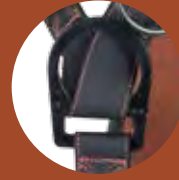

ID plate: the plate supports the straps' dorsal intersection, which means the D-ring always stays in place, even after a fall



Phone holder

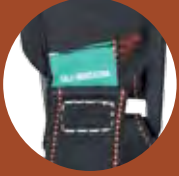

FALL INDICATOR: indicates when the harness has "worked", absorbing such a force that the replacement of the harness is recommended (as it may have partly lost its efficiency).

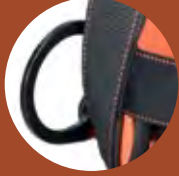

Positioning belt: with padded mesh netting and a lateral, curved D-ring, for increased comfort while working. The belt is fitted with a larger handle on the back to attach extra carabiners or accessories.



Suspension straps: Article AKISO1, specially designed to reduce the harmful effects of being temporarily suspended after a fall. If necessary, take out the two straps, bind them together and rest your feet on the suspension cable while awaiting help (see on the next pages).



AK650 EXCLUSIVE HARNESS EN361- EN358 - EN813

Anchorage point: full body harness with positioning belt with D-ring, back extension band and D-rings for chest anchorage. Central ring for rope access. Two D-rings at waist for positioning rope. Stretch upper part. Buckles with quick release.

Accessories: padded back, positioning belt and leg straps, and more (see features above)

Full box: 1 pcs. (backpack included)

backpack
included





tested
136 Kg

- All Akrobat harnesses are certified 100 kg. as the EN361 standard only provides for this type of verification but in truth they are all tested up to 136 kg.

Size
ADJUSTABLE

**AK8730
FULL BODY JACKET
HARNESS AKROBAT
PLUS
EN361**

Made up by harness AK30 and a comfortable multi pockets cotton vest. This PPE keeps all the features of harness AK30 (see page before)

Size: adjustable. Thanks to a front zippers system, it is possible to fit up to 3 different size adjustments.

Full box: 5 pcs.

**AK136
WIDE OPINING
CARABINER
EN362**

Aluminum hook. Opening: 60 mm
Strength: 23 KN
Full box: 10 pcs.



**AK9427
CARABINER
EN362**

Stainless steel carabiner with screw locking system.
Opening: 18 mm.
Strength: 23 KN
Full box: 20 pcs.



**AK9421
LIGHT ALLOY CARABINER
EN362**

Aluminum alloy carabiner with self-locking system to be used for positioning only. Opening: 21.5 mm
Strength: 23 KN
Full box: 20 pcs.



**AK9426
ALLUMINUM CARABINER
TWIST LOCK
EN362**

Aluminum carabiner with selfclosing system with quarter turn nut.
Opening: 21 mm.
Strength: 23 KN
Full box: 20 pcs.



**AK103
AKROBAT PLUS POSITIONING BELT
WITH CARABINER
EN358**

Adjustable work positioning lanyard with self-locking aluminum carabiner. Packaged in blister.
Length: 2 mt
Full box: 10 pcs.
Note to be used only with positioning belt. (see note for art AK10)



**AK10
AKROBAT PLUS POSITIONING BELT
WITH CARABINER
EN358**

Positioning belt with two lateral rings.
Full box: 10 pcs.
Note: it has to be used only as a work positioning system together with lanyard AK103 and not as a fall arrest system.



**AK246PR
POSITIONING ADJUSTABLE
LANYARD WITH CARABINERS
EN 358:1999**

Positioning lanyard with stainless steel rope grab for easy length adjustment. Maximum length is 2 mt. Equipped with protecting covering sleeve and 2 carabiners.
Full box: 20 pcs.
Note it has to be used only with positioning belt (see note below art AK10)

**RECOMMENDED
FIRST LEVEL
SCAFFOLDING**



**RESTRAINT ROPE LANYARD
EN354**

AK9423 1,0 mt - Ø 12 mm
AK9424 1,5 mt - Ø 12 mm
Full box: 10 pcs.



**AK9417
RETRACTABLE
WEBBING FALL
ARRESTOR
EN360**

Retractable webbing fall arrestor, 2,5 mt long with energy absorber. Equipped with plastic shell and two carabiners.
Full box: 5 pcs.



**AK9417SW
VERSION WITH
SWIVELING FALL
INDICATOR
EN360**

Retractable webbing fall arrestor, 2,5 mt long with energy absorber. Equipped with plastic shell, two carabiners and swiveling fall indicator. If the swivel fall indicator becomes red, the device must be revised.
Full box: 5 pcs.



If the swiveling fall indicator becomes red, the device must be revised.

**certified for
people up to
140 Kg**

**Suggested
in case of
solar panels**



**AKTESS05
RETRACTABLE DEVICE
EN360**

Suggested with photovoltaic panel
Webbing retractable fall arrestor provided with swiveling carabiner with double safety control.
Length of webbing: 5 mt.
Fall indicator. Shock resistant casing made in ABS.
Weight: 3,25 kg

**AKTESS12
RETRACTABLE DEVICE
EN360**

Suggested with photovoltaic panel
Webbing retractable fall arrestor provided with swiveling carabiner with double safety control.
Length of webbing: 12 mt.
Fall indicator. Shock resistant casing made in ABS.
Weight: 5,90 kg



If the swiveling fall indicator becomes red, the device must be revised.





certified for
people up to
140 Kg

**AKBLOCK035
RETRACTABLE DEVICE
EN360**

Retractable fall arrestor with steel rope. Length 3,5 meters.
Provided with swiveling carabiner with double safety control.
Fall indicator. Shock resistant casing made in ABS.
Weight: 2,2 kg



If the swiveling fall indicator becomes red, the device must be revised.



**AKBLOCK05
RETRACTABLE DEVICE
EN360**

Retractable fall arrestor with steel rope. Length 5 meters.
Provided with swiveling carabiner with double safety control.
Fall indicator. Shock resistant casing made in ABS.
Weight: 3,1 kg



If the swiveling fall indicator becomes red, the device must be revised.



**AKBLOCK10
RETRACTABLE DEVICE
EN360**

Retractable fall arrestor with steel rope. Length 10 meters.
Provided with swiveling carabiner with double safety control.
Fall indicator. Shock resistant casing made in ABS.
Weight: 4,1 kg



If the swiveling fall indicator becomes red, the device must be revised.



**AKBLOCK15
RETRACTABLE DEVICE
EN360**

Retractable fall arrestor with steel rope. Length 15 meters.
Provided with swiveling carabiner with double safety control.
Fall indicator. Shock resistant casing made in ABS.
Weight: 6,4 kg



If the swiveling fall indicator becomes red, the device must be revised.





certified for
people up to
140 Kg

**AKBLOCK20
RETRACTABLE DEVICE
EN360**

Retractable fall arrestor with steel rope. Length 20 meters.
Provided with swiveling carabiner with double safety control.
Fall indicator. Shock resistant casing made in ABS.

Weight: 7,4 kg



If the swiveling fall indicator becomes red, the device must be revised.



**AKBLOCK25
RETRACTABLE DEVICE
EN360**

Retractable fall arrestor with steel rope. Length 25 meters.
Provided with swiveling carabiner with double safety control.
Fall indicator. Shock resistant casing made in ABS.

Weight: 12,5 kg



If the swiveling fall indicator becomes red, the device must be revised.



**AKBLOCK30
RETRACTABLE DEVICE
EN360**

Retractable fall arrestor with steel rope. Length 30 meters.
Provided with swiveling carabiner with double safety control.

Fall indicator. Shock resistant casing made in ABS.
Weight: 12,9 kg



If the swiveling fall indicator becomes red, the device must be revised.

**CERTIFIED FOR
HORIZONTAL USE.**

**AKORIZ10
RETRACTABLE BLOCK
FOR HORIZONTAL USE
EN 360 - VG11 RFU
11.060**

Retractable device with 10 mt long galvanized steel wire rope.

It is suggested for horizontal use and complies with the new rules satisfies the new legal requirements concerning the edge test, the length of the outside of reel case not over 60 cm and the prohibition of attaching any removable device to the terminal.

Weight: 4,96 Kg
Full box: 1 pcs.

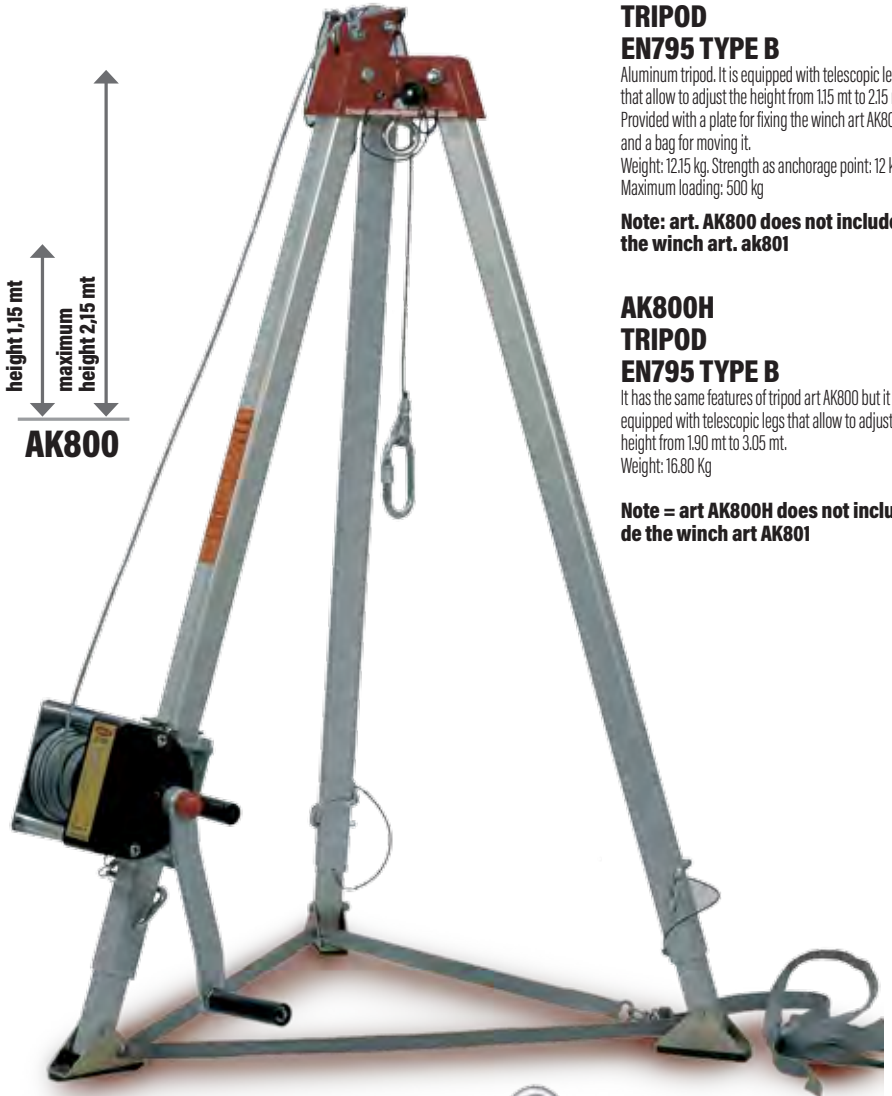
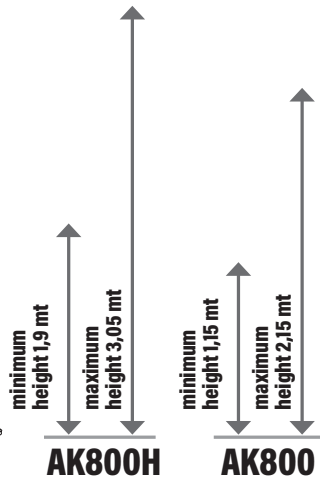
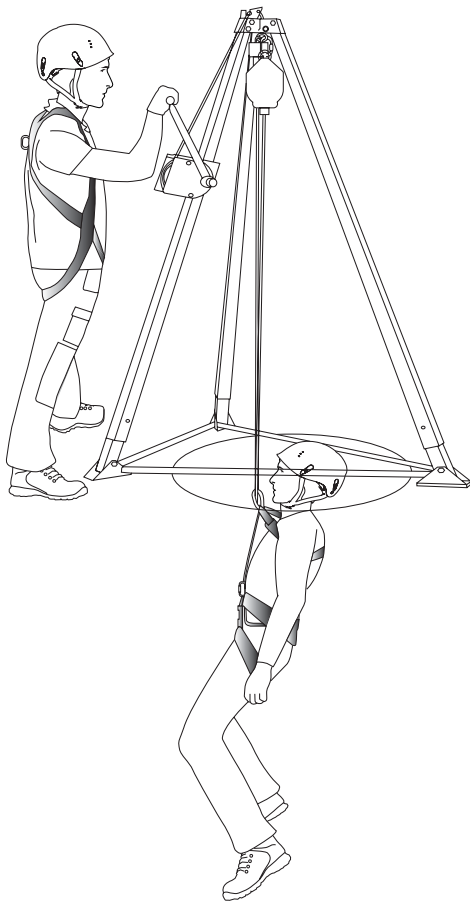

**AK800
TRIPOD
EN795 TYPE B**

Aluminum tripod. It is equipped with telescopic legs that allow to adjust the height from 1.15 mt to 2.15 mt. Provided with a plate for fixing the winch art AK801 and a bag for moving it.
 Weight: 12.15 kg. Strength as anchorage point: 12 kN. Maximum loading: 500 kg

Note: art. AK800 does not include the winch art. ak801

**AK800H
TRIPOD
EN795 TYPE B**

It has the same features of tripod art AK800 but it is equipped with telescopic legs that allow to adjust the height from 1.90 mt to 3.05 mt.
 Weight: 16.80 Kg

Note = art AK800H does not include the winch art AK801

**AK801
WINCH FOR AK800
EN1496 - CLASS A**

To be used to lift a person with a max weight of 125 kg in restricted spaces. It must be used together with a retractable fall arrestor AKBLOCK.

N.B.: art AK801 does not include the tripod



AKKITREC30

KIT consisting of a pulley, a plate and a carabiner. To be used to fix AKBLOCK25R on an AK800 or AK800H tripod.



**AKBLOCK25R
RETRACTABLE BLOCK
WITH RETRIEVAL
SYSTEM
EN360:2002 -
EN1496:2017 CLASSE B**

It can be easily shifted to winch mode from block mode through a locking pin. Provided with fall indicator.
Weight: 14,10 Kg

N.B. It is necessary art AKKITREC30 to use it with tripods art AK800 or art AK800H.





**ENERGY ABSORBING ROPE LANYARD
EN355**

AK111S Length 1.5 meters: allowed for harnesses with back extension.

AK112S length 2 meters.

Energy-dissipating lanyard, equipped with a hook and a carabiner. Ensure that there is at least 6 meters between the anchor point and the ground or fall hazard plane.

Full box: 5 pcs.



**ENERGY ABSORBING ROPE LANYARD
EN355**

AK111P Length 1.5 meters: allowed for harness with back extension

AK112P Length 2 meters.

Lanyard with energy dissipator, supplied with a 60 mm opening hook and a carabiner. Make sure there is at least 6 meters between the anchor point and the ground or fall hazard plane.

Full box: 5 pcs.



**AK398
ELASTICIZED ROPE
EN355**

Elasticized rope with energy dissipator, equipped with 60 mm opening hook and a carabiner. The advantage of this dissipator, compared with the others, is the smaller size of the textile rope when elastic "relaxed".

Length: with "relaxed" elastic 1.4 m, with "taut" elastic 2 m. Make sure there is at least 6 m between the anchor point and the ground or fall hazard plane.

Full box: 5 pcs.



**ENERGY ABSORBING FORKED ROPE LANYARD
EN355**

AK349 Length 1.5 meters: allowed for harness with extension back.

AK351 Length 2 meters.

Energy dissipator with two hooks and a carabiner. Ideal for moving while maintaining a fixed anchor point at all times. E.g., maintenance on a crane boom, climbing pylons, etc. Make sure there is at least 6 meters between the anchor point and the ground (or fall hazard plane).

Full box: 5 pcs.



**AK371 ENERGY ABSORBING FORKED ROPE
LANYARD
EN355:2002**

Energy dissipator with elasticized rope and two hooks and a carabiner. Ideal for moving around while maintaining a fixed anchor point at all times. E.g., maintenance on crane boom, climbing pylons, etc. Make sure there is at least 6 meters between the anchor point and the ground (or fall hazard plane).

Length: with "relaxed" elastic 1.4/1.6 meters; with "taut" elastic 2.0 meters.

Full box: 10 pcs.



**AK3000
TEMPORARY HORIZONTAL
ANCHORAGE LIFELINE
EN795-B**

Temporary anchorage lifeline with maximum length of 20 meters. Certified EN 795 B. It can be used by two people simultaneously. Supplied in a practical bag. Provided with two safety carabiners (included). The ends do not require any additional webbing. Recommended for scaffolding, roofs, etc.
Full box: 5 pcs.

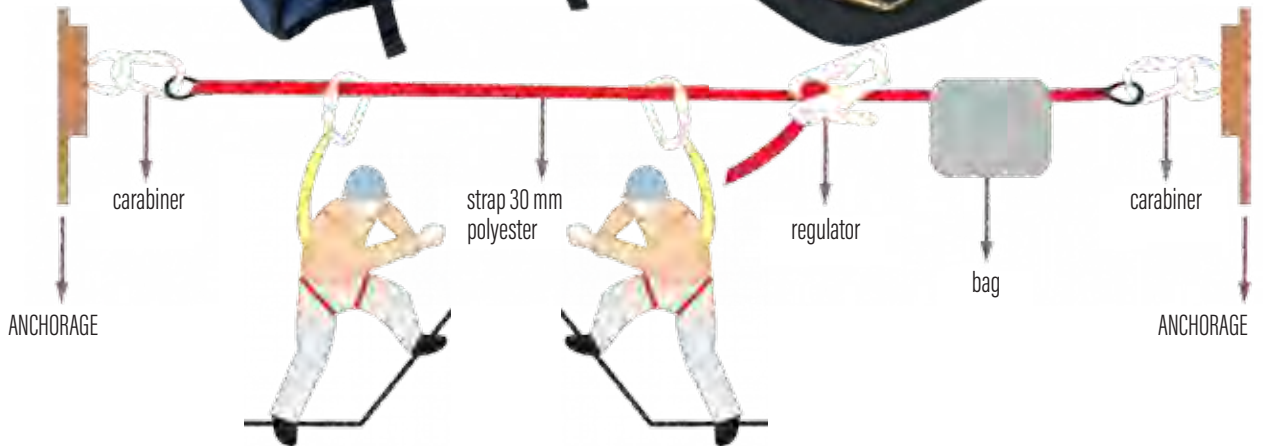

**AK2000B
SLIDING DEVICE
EN353-2**

Sliding device that can be open. With both automatic and manual locking system. Energy absorber and carabiner included. To be used only with ropes AK9410/20/30. Suggested for securing stairs and inclined floors.
Full box: 5 pcs.



SEMISTATIC ROPE *only on request*

Semi-static 10.5 mm type A rope in different sizes.

Ref.	measure	standard	packaging
09510	10 m	EN1891	10 pcs
09520	20 m	EN1891	10 pcs
09530	30 m	EN1891	10 pcs
09503	200 m	EN1891	1 pcs reel
09505	100 m	EN1891	1 pcs coil
09507	50 m	EN1891	1 pcs coil



**SAFETY ROPE
EN353-2**

AK9410 10 mt
AK9420 20 mt

16 mm diameter rope of different lengths with wear test. For use with AK2000B. Recommended for securing ladders and inclined planes.
Packages:
AK9410: 10 pcs.
AK9420: 10 pcs.

NB: the rope is certified only when used with AK2000B sliding device.



**AK200420
GUIDED TYPE FALL
ARRESTER
EN 353-2**

Fall arrester sliding device that can not be opened. Supplied with two carabiners, energy absorber and 20 mt long rope. Recommended for stairs and inclined floors.
Full box: 5 pcs.





AKSA08
ANCHORAGE POINT ON STEEL
BEAMS T or H
EN795 TYPE B

Brass and aluminium anchorage point. It is suggested for steel beams.
Weight: 1550 gr.



AK802
DOOR / WINDOW ANCHOR POINT
EN795:2012 TYPE B

Aluminum anchor which is very resistant and lightweight (only 4.80 kg). It can be easily installed just compressing it against door or window frame. It can be easily installed just compressing it against open door or window frame.
Full box: 1 pcs.



AKSA09
ANCHORAGE POINT
EN795 TYPE A

Aluminium anchorage point to be fixed with plugs (not included).
Full box: 5 pcs.



AKSA16
CONCRETE ANCHOR (REUSABLE)
EN795:2012

This anchor point can be easily installed through a 110 mm deep hole. Once the anchor point is put inside the hole and twisted, the flanges come out and fix it to the wall. Resistant up to 12 KN.
Full box: 50 pcs.



**AKSA11
ANCHORAGE POINT FOR PARAPETS
EN795 TYPE B**

Anchorage point for parapets made in galvanized steel (for protection against corrosion).
Weight: 8,60 kg.



**AK80415
ANCHORAGE POINT
EN795 TYPE B**

Anchorage point with metal D-rings at both sides. Certificated with strength 15KN.
Length: 1,5 mt
Full box: 10 pcs.



**AK80710
ANCHORAGE SLING
EN795 TYPE B**

Anchorage sling. Certificated with strength 10 KN,
length 1 m
Full box: 10 pcs.



**AKTL01
TOOLS LANYARD**

(colour 031 orange fluo)
The lanyard is equipped with a light carabiner to be hung to the belt. In contracted position, it is 85 cm long, in maximum extension it is 135 cm long. Packed in polybags of 2 pcs.
Full box: 50 polybags
Minimum quantity: 2 pcs. (1 polybag of 2 pcs.).

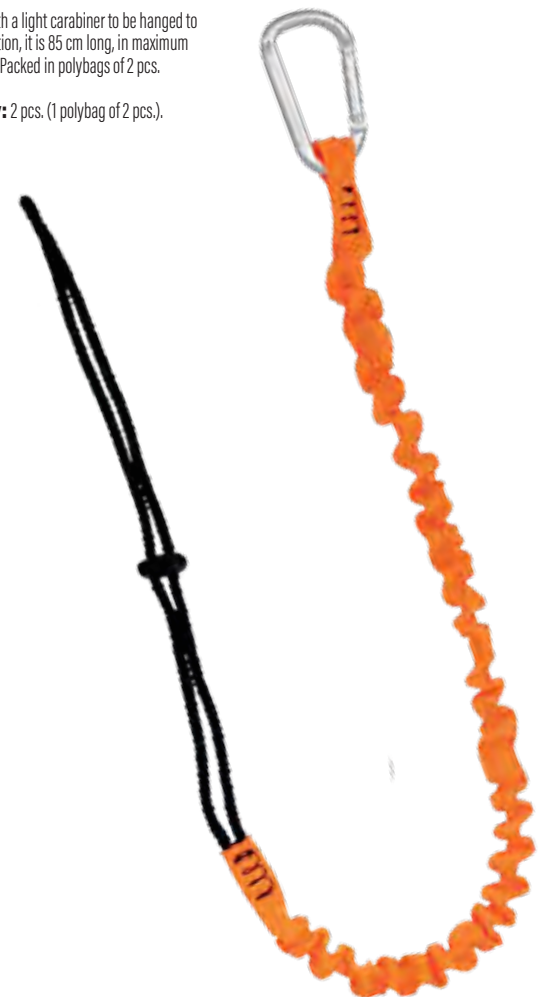



Akrobat Ready-to-use kits.
The practical solution for all needs:

**AKKIT02
POSITIONING KIT**

Composition:
- positioning belt AK10
- positioning lanyard AK103 with self-locking carabiner
Features: the positioning system makes easier working in height. It is not a fall arrest system.
In resealable polyethylene bag.
Full box: 5 pcs.



NEW

**AKKIT03
KIT SCAFFOLDING**

Composition:
Anchorage harness back AK002 EN 361.
Rope AK9423 EN 354.
2 carabiners AK9427 EN 362.
Packaged in a bag.
Features: this kit is ideal for occasional rope work.
In resealable polyethylene bag.
Full box: 5 pcs.



**AKKIT04P
KIT SCAFFOLDING**

Composition:
Harness AK003 with chest and back anchorage points Lanyard AK112P with energy absorber, hook and carabiner.
Bag AK903 that can contain also a helmet (not supplied, AK905N recommended)
Features: this kit is a fall arrest system ideal for working in height.
Pay attention to vertical clearance. It is recommended that there are at least 6 mt between the anchorage point and the ground or fall risk's surface.
Full box: 5 pcs.



**AKKIT05 only on request
KIT SCAFFOLDING PLUS**

Composition:
Harness with back anchorage AK20 PLUS EN 361.
Rope AK9423 EN 354.
2 carabiners AK9427 EN 362.
Packaged in a bag.
Features: This kit is ideal for rope access work.
In polyethylene bag resealable.
Full box: 5 pcs.



**AKKIT07
KIT SCAFFOLDING**

Composition:
- Harness art AK003 with back and chest anchorage points
- Lanyard art AK303 with energy absorber and 2 hooks.
Features: this KIT is a fall arrest system for people working in height and who need the energy absorber in case of fall. It is recommended that there are at least 6 mt between the anchorage point and the ground or fall risk's surface.
Full box: 5 pcs.



AKKIT05 only on request

Composition:
Anchorage back harness AK20 PLUS EN 361.
AK200420 EN 353 guiding device without opening.
All in a bag large enough to hold a helmet (not included in the KIT).
Features: The KIT constitutes an ideal fall arrest system for safety when ascending and descending stairs or at inclined planes.
Full box: 5 pcs.





NEW

**AKKIT08
LADDER AND ROOF KITS**

Composition:

Harness AK005 back and chest attachment, positioning belt.
AK103 positioning lanyard with carabiner.
AK200420 sliding guided device, two carabiners, dissipator and 20 m of rope.
AK902 large bag to also hold a helmet (not provided in KIT, AK905N or AK9055 recommended)
Features: The KIT makes an ideal fall arrest system for work at height, watch out for the air pull.
It is recommended to make sure that there is at least 6 meters between the anchor point and the ground or plane of fall risk
Full box: 5 pcs.



NEW

**AKKIT09
FORCHED KIT**

Composition:

- AK003 harness with dorsal and sternal attachment
- Forched AK351 2 m, energy absorbing rope, 2 clamps and carabiner.
- Bag AK903 can also contain a helmet (not supplied in the KIT, AK905N or AK9055 is recommended)

Features: The KIT make an ideal fall arrest system for work at height, Pay attention to pay attention to the air draft. It is recommended to make sure that there is at least 6 meters between the anchor point and the ground or fall hazard plane.
Full box: 5 pcs.



**AK902
BIG BAG**

Dimensions in cm:
67 width
17 depth
23 height



**AK903
SMALL BAG**

Dimensions in cm:
44 width
18 depth
23 height



**AK9400
BACKPACK**

Dimensions in cm:
30 width
14 depth
37,5 height





AK8100 *only on request*
LONG COAT AKROBAT
Colour: red
Sizes: M-L-XL
Full box: 20 pcs.

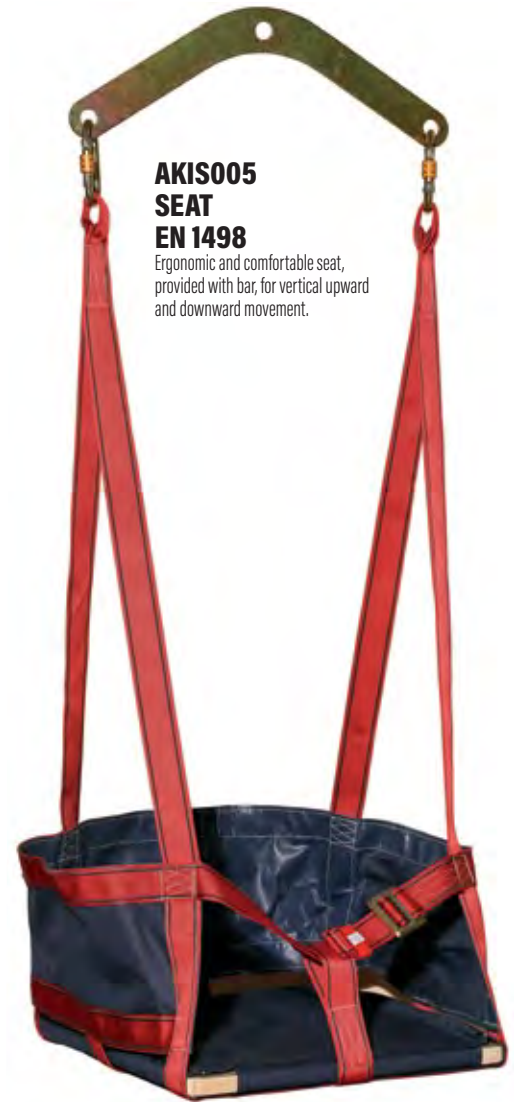

**AKIS005
SEAT
EN 1498**
Ergonomic and comfortable seat,
provided with bar, for vertical upward
and downward movement.



FALL ARREST DISPLAY
Floor display, in painted metal. Modular.
(Supplied without products)
See specifications on page of exhibitors.



Safety footwear

ISSALINE safety footwear is specially designed to ensure the safety of feet while performing work activities.

They are made of sturdy materials that are resistant to various external agents such as shocks, splinters, chemicals and liquids, and can prevent injuries caused by falling heavy or sharp objects.

Using safety footwear properly can significantly reduce the number of workplace injuries. The feet are one of the most vulnerable parts of the human body, so protecting them is of paramount importance.

ISSALINE's safety footwear has a durable protective sole, which provides a non-slip surface and reduces the risk of falls. In addition, these shoes have a steel or composite toe cap, which protects toes from impact and compression, and a puncture-resistant insole to prevent injury from penetrating objects such as nails or splinters.

In addition to physical protection, ISSALINE footwear provides comfort and support to workers. Their ability to conform to the shape of the foot and absorb shock reduces fatigue and the risk of muscle fatigue, improving productivity and quality of work.

Safe and comfortable footwear

ISSALINE safety shoes provide maximum protection and comfort for the wearer, as well as strength and durability.

For this reason, making a safety shoe requires great care in the choice of materials and design of the various components.

In addition to the toe cap, which is essential to protect the toes from possible impacts, the upper can be made of different materials such as leather, fabric or synthetic, depending on the need for strength and breathability.

The sole, on the other hand, can be made of rubber or polyurethane and can be single-density or dual-density, depending on the foot's anti-slip and cushioning requirements.

Other important details to consider are the inner lining, which should be soft and breathable, and the closure, which can be with laces or Velcro, depending on the user's preference.

Finally, a key aspect to consider is the ergonomics of the shoe, which must fit perfectly to the shape of the foot and ensure maximum comfort during prolonged use.

In conclusion, the safety of an accident prevention shoe comes from the care and quality of the materials used, as well as the correct design of the different components that make it up.



- 1 Tread
- 2 Shock absorber
- 3 Anti-puncture insole
- 4 Toe cap
- 5 Anatomical insole
- 6 Upper
- 7 Non-allergenic lining



INDUSTRY

INDUSTRIAL SAFETY FOOTWEAR WITH POLYURETHANE (PU) SOLE



INDUSTRY

A range of safety footwear designed for industry, featuring a dual-density polyurethane (PU) sole. This sole offers the worker an optimal level of comfort due to its flexibility and ensures greater safety by providing better thermal insulation and slip resistance. The main objective is to ensure a comfortable and safe working environment for personnel.

46457

EN ISO 20345 S3

Upper: high, water repellent in pigmented leather

Toe: steel

Anti-perforation foil: steel

Sole: single density non-slip PU

Sizes: from 38 to 47

S3



First price



35120 TIRSO

EN ISO 20345 S1P SRC

Upper: low, perforated suede leather

Toe: steel

Anti-perforation foil: steel

Sole: non-slip dual density PU

Plus: padded collar for better comfort, front part without seams to reduce the risk of damages and ensure an higher resistance.

Sizes: from 36 to 48

S1P



36140 EBRO

EN ISO 20345 S3 SRC

Upper: high, water repellent specific for welders, printed full grain leather.

Toe: steel

Anti-perforation foil: steel

Sole: non-slip dual density PU

Plus: bellows cover (elastic and not laces) to protect from sparks, closure with quick release buckle. Aramid fiber seams, they assure a great resistance from welding sparks and abrasion.

Sizes: from 36 to 48

S3



FOR WELDERS

ARAMID fiber seams
> Abrasion-resistant
> Resistant to sparks



36180 ODER *only on request*

EN ISO 20345 S3 SRC CI

Padded winter boot

Upper: water repellent in printed grain leather

Toe: steel

Anti-perforation foil: steel

Sole: non-slip dual density PU

Plus: padded collar for better comfort, front part without seams to reduce the risk of breaking and ensure better strength. Padded with synthetic fur, it is certified anti-cold

Sizes: from 36 to 48

S3



36175 BARROW *only on request*

EN ISO 20345 S3 SRC CI

Padded winter boot

Upper: water repellent in printed grain leather

Toe: steel

Anti-perforation foil: steel

Sole: non-slip dual density PU

Plus: padded collar for better comfort, front part without seams to reduce the risk of breaking and ensure better strength. Padded with synthetic fur, it is certified anti-cold

Sizes: from 36 to 48

S3





35100 JUCAR
EN ISO 20345 S1P SRC

Upper: low, printed full grain leather
Toe: steel

Anti-perforation foil: steel

Sole: non-slip dual density PU

Plus: padded collar for better comfort, front part without seams to reduce the risk of damages and ensure a higher resistance.

Sizes: from 36 to 48



35110 TURIA
EN ISO 20345 S1P SRC

Upper: high, printed grain leather

Toe: steel

Anti-perforation foil: steel

Sole: non-slip dual density PU

Plus: padded collar for better comfort, front part without seams to reduce the risk of damages and ensure a higher resistance.

Sizes: from 36 to 48



36100 LAMBRO
EN ISO 20345 S3 SRC

Upper: low, water repellent in printed grain leather

Toe: steel

Anti-perforation foil: steel

Sole: non-slip dual density PU

Plus: padded collar for better comfort, front part without seams to reduce the risk of damages and ensure an higher resistance.

Sizes: from 36 to 48



36110 BRENTA
EN ISO 20345 S3 SRC

Upper: high, water repellent in printed grain leather

Toe: steel

Anti-perforation foil: steel

Sole: non-slip dual density PU

Plus: padded collar for better comfort, front part without seams to reduce the risk of damages and ensure an higher resistance.

Sizes: from 36 to 48





42195R NEW MARATHON
EN ISO 20345 SIP SRC

Upper: low, in suede and abrasion resistant, breathable mesh fabric.

Toe: steel

Anti-perforation foil: steel

Sole: non-slip dual density PU

Plus: padded collar for better comfort and breathable upper thanks to the mesh fabric.

Sizes: from 36 to 48



06893R SPARTA
EN ISO 20345 SIP SRC

Upper: low, in suede and abrasion resistant, breathable mesh fabric.

Toe: steel

Anti-perforation foil: steel

Sole: non-slip dual density PU

Plus: padded collar for better comfort and breathable upper thanks to the mesh fabric. Metal lace hooks.

Sizes: from 36 to 48



06897R ATENE
EN ISO 20345 SIP SRC

Upper: high, in suede and abrasion resistant and breathable mesh fabric.

Toe: steel

Anti-perforation foil: steel

Sole: non-slip dual density PU

Plus: padded collar for better comfort and breathable upper thanks to the mesh fabric. Metal lace hooks.

Sizes: from 36 to 48





INDUSTRY PLUS

Given the high reliability of the Industry double density sole, we created an ISSALINE Industry Plus range which, starting from the same tread, it develops "richer" uppers and seeks flexibility and lightness also thanks to the use of fiber glass toe cap and textile anti-perforation insole. Other characteristics of the range being Metal Free (could there are exceptions) and have colored soles. All this with a surprising prices, giving to ISSALINE Industry Plus the range of ISSALINE footwear with the best price/quality ratio.

35060N PADDLE

EN ISO 20345 S1P SRC METAL FREE

Upper: low, in suede leather with breathable contrasting very strong fabric inserts.

Toe: fiberglass

Anti-perforation foil: textile

Sole: non-slip dual density PU

Plus: metal free, flexibility, lightness and comfort allow a use both indoors and on uneven surfaces (dirt roads, construction sites, etc.).

Sizes: from 36 to 48

Colour: beige/inserts black, yellow



35055N STATION

EN ISO 20345 S1P SRC METAL FREE

Upper: low, in suede leather with breathable contrasting very strong fabric inserts. **Toe:** fiberglass

Anti-perforation foil: textile

Sole: non-slip dual density PU

Plus: metal free, flexibility, lightness and comfort allow a use both indoors and on uneven surfaces (dirt roads, construction sites, etc.).

Sizes: from 36 to 48

Colour: blue/inserts grey, orange



36200N TACKLE

EN ISO 20345 S3 SRC METAL FREE

Upper: low, water repellent in action nubuck leather with contrasting very strong fabric inserts.

Toe: fiberglass

Anti-perforation foil: textile

Sole: non-slip dual density PU

Plus: metal free, flexibility, lightness and comfort allow to use it indoors and especially outdoors on uneven surfaces (dirt roads, construction sites, etc.).

Sizes: from 36 to 48



36210N CORNER

EN ISO 20345 S3 SRC METAL FREE

Upper: high, water repellent in action nubuck leather with contrasting very strong fabric insert.

Toe: fiberglass

Anti-perforation foil: textile

Sole: non-slip dual density PU

Plus: metal free, flexibility, lightness and comfort allow to use it indoors and especially outdoors on uneven surfaces (dirt roads, construction sites, etc.).

Sizes: from 36 to 48



ISSALINE



35078 EKAR
EN ISO 20345 SIP SRC **METAL FREE**

SIP

Upper: Action Leather con inserts Mesh

Toe: fiberglass

Anti-perforation foil: textile

Sole: non-slip dual density PU

Plus: metal free, flexibility, lightness and comfort allow a use both indoors and on uneven surfaces (dirt roads, construction sites, etc.).

Sizes: from 36 to 48

Colour: blue/inserts verdi, black



36315 COLAC **only on request**
EN ISO 20345 S3 SRC **METAL FREE**

S3

Upper: low, water repellent mixed action leather with similar Cordura inserts.

Toe: fiberglass

Anti-perforation foil: textile

Sole: non-slip dual density PU

Plus: metal free. Waterproof. Very resistant with a front protection.

Sizes: from 36 to 48

Colour: grey with inserts orange



68200R FALCON
EN ISO 20345 S3 SRC

S3

Upper: high, water repellent in full grain nubuck

Toe: fiberglass

Anti-perforation foil: textile

Sole: non-slip dual density PU

Plus: front part without seams to reduce the risk of breaking and ensure greater strength. Excellent grip on the ground. Particularly recommended for outdoor work.

Sizes: from 36 to 47



HEAVY DUTY

68200MR FALCON **only on request**
EN ISO 20345 S3 SRC

S3

Upper: alta idrorepellente in pieno fiore nabuk

Toe: fiberglass

Anti-perforation foil: textile

Sole: non-slip dual density PU

Plus: with membrane. Front part without seams to reduce the risk of breaking and ensure greater strength. Excellent grip on the ground. Particularly recommended for outdoor work.

Sizes: from 36 to 47



MEMBRANE

HEAVY DUTY



68360 RHINO *only on request*
EN ISO 20345 S1P SRC METAL FREE

Upper: low, in suede leather with ventilation holes.

Toe: fiberglass

Anti-perforation foil: textile

Sole: non-slip dual density PU

Plus: metal free, flexibility, lightness and comfort allow a use both indoors and on uneven surfaces (dirt roads, construction sites, etc.).

Sizes: from 36 to 48

S1P



36112 PIAVE *only on request*
EN ISO 20345 S3 SRC METAL FREE

Upper: low, water repellent in printed grain leather.

Toe: fiberglass

Anti-perforation foil: textile

Sole: non-slip dual density PU

Plus: metal free, maximum lightness, padded collar for better comfort, seamless front to reduce the risk of breaking and guarantee greater strength.

Sizes: from 36 to 48

S3

36115 SILE
EN ISO 20345 S3 SRC METAL FREE

Upper: high, water repellent in printed grain leather

Toe: fiberglass

Anti-perforation foil: textile

Sole: non-slip dual density PU

Plus: metal free, maximum lightness, padded collar for better comfort, seamless front to reduce the risk of breakage e guarantee greater strength.

Sizes: from 36 to 48

S3



36300 RACY *only on request*
EN ISO 20345 S3 SRC METAL FREE

Upper: low, water repellent in special seamless fabric high resistance to abrasion. Waterproof membrane.

Toe: fiberglass

Anti-perforation foil: textile

Sole: non-slip dual density PU

Plus: metal free. Waterproof. Very resistant with a front protection.

Sizes: from 36 to 48

Colour: grey/inserts grey, black

S3





ISSALINE
+ PIP



68600 WHISPER *only on request*
EN ISO 20345 S1P SRC ESD METAL FREE

Upper: Low, in suede.
Toe: composite.
Anti-perforation foil: kevlar.
Sole: EVA + non-slip rubber.
Plus: Metal free, breathable fabric lining. Great resistance.
Sizes: from 36 to 48.
Colour: black with red inserts.



68620 RUMBLE *only on request*
EN ISO 20345 S3 SRC ESD METAL FREE

S3

Upper: Low, in suede.
Toe: composite.
Anti-perforation foil: kevlar.
Sole: EVA + non-slip rubber.
Plus: Metal-free, water-repellent and breathable fabric lining. Great resistance.
Sizes: from 36 to 48.
Colour: black with red inserts.



68630 ROAR *only on request*
EN ISO 20345 S3 SRC ESD METAL FREE

S3

Upper: High, in suede.
Toe: composite.
Anti-perforation foil: kevlar.
Sole: EVA + non-slip rubber.
Plus: Metal-free, water-repellent and breathable fabric lining. Great resistance.
Sizes: from 36 to 48.
Colour: black with red inserts.



ISSALINE



35040 VOGA *only on request*
EN ISO 20345 S1P SRC METAL FREE

S1P

Upper: Low in leather.
Toe: composite.
Anti-perforation foil: textile.
Sole: non-slip dual density PU.
Plus: Its flexibility, lightness and comfort allow it to be used both on regular surfaces (indoors) than irregular (external).
Sizes: from 36 to 48.



35162 EVROS *only on request*
EN ISO 20345 S1P SRC METAL FREE

S1P

Upper: Low in suede.
Toe: fiberglass.
Anti-perforation foil: textile.
Sole: non-slip dual density PU.
Plus: Velcro closure, side opening for better breathability.
Sizes: from 36 to 47.





EXTREME

ISSALINE has created a new concept of work footwear, taking inspiration from the clothing of the EXTREME line. A line of safety shoes has been developed that is detaches itself from traditional models, using materials from sports footwear sector. The dual density polyurethane sole and the adoption of the system SHK (shaft) ensure a high level of comfort on any type of terrain.



44220 EXTREME EN ISO 20345 SIP SRC ESD METAL FREE

Upper: midy, breathable textile with abrasion resistant overcoat.
Toe: fiberglass. **Anti-perforation foil:** textile.
Sole: non-slip dual density PU. **Insole:** textile comfort foam system
Plus: collar and stretch tongue that guarantee greater comfort and SHK SYSTEM shank in stabilizing nylon / pu.
Sizes: 36-48
Colour: blue with black and lime green inserts



44400 EXTREME STRETCH SLIP ON EN ISO 20345 SIP SRC METAL FREE

Upper: midy textile traspirante con spunterbo antiabrasione.
Toe: fiberglass. **Anti-perforation foil:** textile.
Sole: non-slip dual density PU. **Insole:** textile comfort foam system
Plus: collar and stretch tongue that guarantee greater comfort and SHK SYSTEM shank in stabilizing nylon / pu.
Sizes: 36-48
Colour: blue with black and orange inserts.



EXTREME

46205 EXTREME STRETCH SLIP ON EN ISO 20345 S3 SRC ESD METAL FREE

Upper: low, in water-resistant and breathable mesh with anti-abrasion overcap.
Toe: fiberglass. **Anti-perforation foil:** textile
Sole: non-slip dual density PU. **Insole:** textile comfort foam system
SHK SYSTEM: stabilizing nylon / pu shank
Sizes: 36-48
Colour: grey / black with blue inserts

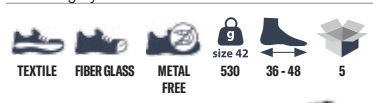

46305 EXTREME STRETCH EN ISO 20345 S3 SRC ESD METAL FREE

Upper: high, in water-resistant and breathable mesh with anti-abrasion overcap.
Toe: fiberglass. **Anti-perforation foil:** textile
Sole: non-slip dual density PU. **Insole:** textile comfort foam system
SHK SYSTEM: stabilizing nylon / pu shank
Sizes: 36-48
Colour: grey / black with blue inserts

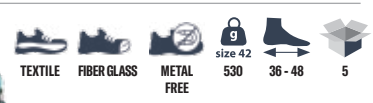

46200 EXTREME STRETCH SLIP ON EN ISO 20345 S3 SRC ESD METAL FREE

Upper: low, in water-resistant and breathable mesh with anti-abrasion overcap.
Toe: fiberglass. **Anti-perforation foil:** textile
Sole: non-slip dual density PU. **Insole:** textile comfort foam system
SHK SYSTEM: stabilizing nylon / pu shank
Sizes: 36-48
Colour: grey / black with orange inserts

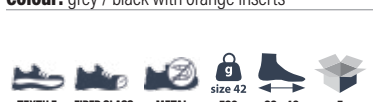

46300 EXTREME EN ISO 20345 S3 SRC ESD METAL FREE

Upper: high, in water-resistant and breathable mesh with anti-abrasion overcap.
Toe: fiberglass. **Anti-perforation foil:** textile
Sole: non-slip dual density PU. **Insole:** textile comfort foam system
SHK SYSTEM: stabilizing nylon / pu shank
Sizes: 36-48
Colour: grey / black with orange inserts

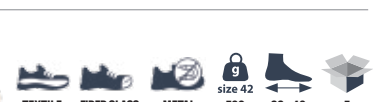



PROFESSIONAL & SPORT

Some products are part of this range, designed for those people who do not need a shoe with safety cup, foil or for those people how are looking for a product with a excellent value for money for leisure time.



06788 CIAMPAC 20347 OB E SRC

Upper: action leather with inserts like in cordura fabric.
Toe: no **Anti-perforation foil:** no **Sole:** SRC non slip EVA rubber
Plus: materials and look allow use also for leisure time.
Sizes: from 38 to 47
Colour: grey/inserts orange



**CERTIFICATED ANTISLIPPING.
Whitout cup and foil.**

06786 AIRY NO SAFETY

Upper: action leather with inserts like in cordura fabric.
Toe: no **Anti-perforation foil:** no
Midssole: EVA to ensure comfort and weight cushioning
Sole: thermoplastic rubber tread (TPR)
Plus: excellent slip resistance. Recommended use for leisure time
Sizes: from 38 to 47
Colour: blue/inserts green, black



06782 VENS NO SAFETY

Upper: water resistant softshell fabric with membrane
Toe: no **Anti-perforation foil:** no **Sole:** EVA and non-slip rubber
Plus: very light. Sole with excellent grip. Materials and look allow use also for leisure time.
Sizes: from 38 to 47
Colour: blue/inserts orange



06783 PLOSE NO SAFETY

Upper: water resistant softshell fabric with membrane
Toe: no **Anti-perforation foil:** no **Sole:** EVA and non-slip rubber
Plus: very light. Sole with excellent grip. Materials and look allow use also for leisure time.
Sizes: from 38 to 47
Colour: blue/inserts orange



ISSALINE

PROFESSIONAL & SPORT





WHITE

ISSALINE work footwear is the ideal choice for people that work in the food or hospitality Industries. Made from high-quality materials, the PU Polyurethane soles provide excellent slip resistance, ensuring safety and stability during use. Uppers are available in either microfiber or leather, both of which are highly durable and easy to clean. These features make our work footwear perfect for use in food and hospitality companies, where hygiene is paramount and workplace safety is a priority.

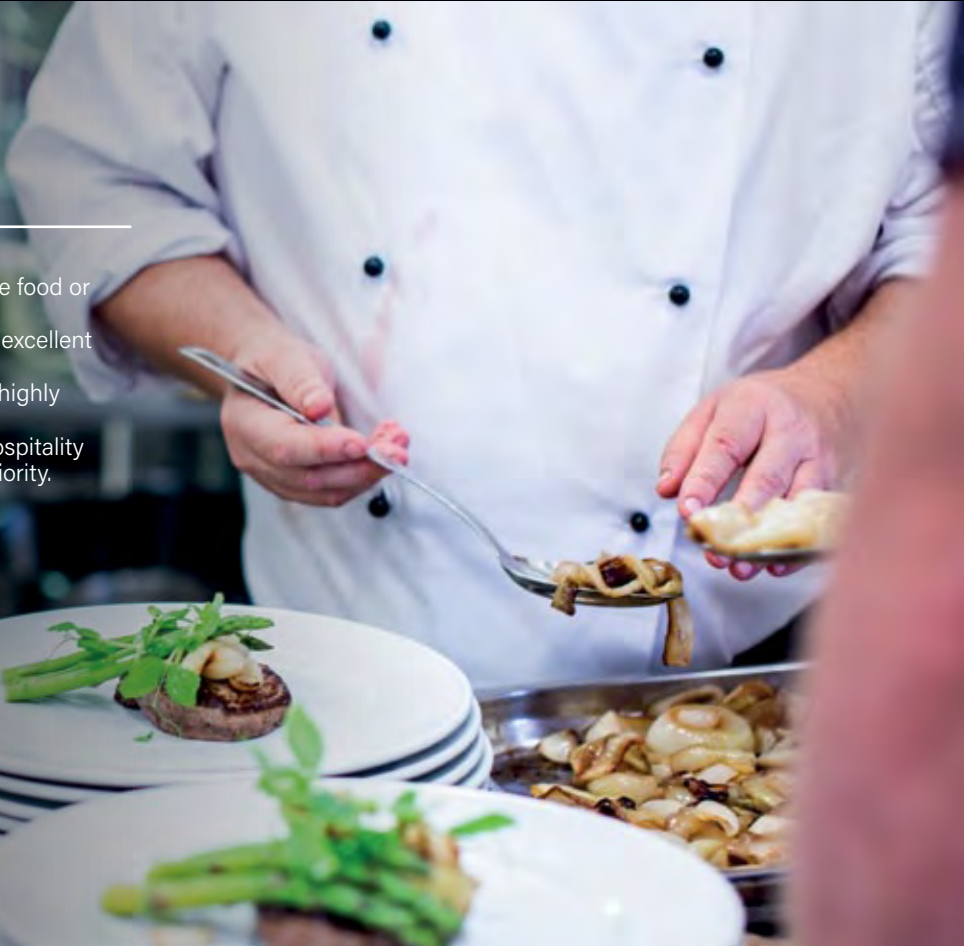

41630G SNOW

EN ISO 20345 S2 SRC

Upper: low, microfiber suitable for food production use.

Toe: fiberglass

Anti-perforation foil: no

Sole: non-slip PU

Plus: metal free, particularly light and flexible

Sizes: from 35 to 47



37865 TAJO **only on request**

EN ISO 20345 S2 SRC

Upper: low, microfiber suitable for food production use.

Toe: steel

Anti-perforation foil: no

Sole: non-slip PU

Sizes: from 36 to 46



06755

SABOT MAN

Upper: perforated leather and padded on the edges.

Sole: non-slip PU

Plus: soft pig insole

Sizes: from 40 to 46



06750

SABOT WOMAN

Upper: perforated leather and padded on the edges.

Sole: non-slip PU

Plus: soft pig insole

Sizes: from 35 to 41





Polymer rubber or EVA clogs are certified for a wide range of work uses, recommended in areas such as hospitals, doctors' offices, physical therapists, cleaning companies and health clubs, as well as in the hotel industry and other similar facilities. Their non-slip SRC sole provides good grip on a variety of surfaces, preventing accidental falls and improving workplace safety. They are hygienic and can be easily sterilized or cleaned after use. In addition, with their ergonomic design and adjustable flip-up foot strap for foot safety, they offer high comfort even during long working hours. In summary, our range of clogs offers a complete and efficient solution for professional needs.

06770
SABOT SAFE
EN ISO 20345:2011 SB A E SRC ESD

Produced in Italy
Upper: in natural thermoplastic polymer rubber, latex free. Upper with closed top to prevent infiltration of organic and harmful substances.
Sterilizable: in autoclave (up to 134 ° C for 70 minutes)
Toe: in 200J steel
Anti-perforation foil: no
Sole: polymer rubber (SRC anti-slip)
Plus: side windows for foot ventilation and washing. Energy absorption in the heel area, anatomic footbed, safety flip-up strap with patented attachment, ESD.
Use: Recommended for hospitals, doctors' offices, industries, hotel industry, health clubs, etc.
Sizes: from 35 to 47
Colours: 050 white, 060 black
On request: blue royal.

Microchip installation on request.



COLOR AVAILABLE ON REQUEST



06765
SABOT LIGHT IN EVA
EN ISO 20347:2012 OB A E SRC

Produced in Italy
Upper: in very light cross-linked eva (only 200 grams per pair). Upper with closed top for prevent infiltration of organic and harmful substances
Washable: up to 60° C.
Toe: no
Anti-perforation foil: no
Sole: eva (SRC anti-slip)
Plus: side holes for foot ventilation. Energy absorption in the heel area, anatomic footbed, safety flip-up strap. Antistatic plug for the discharge of electrostatic charges, antibacterial insole.
Use: Recommended for hospitals, medical offices, physical therapists, cleaning companies, health clubs, hotels, etc.
Sizes: from 35 to 46
Colours: 050 white, 040 blue navy
On request: sky blue, green, black, purple.



COLOR AVAILABLE ON REQUEST



06760N
SABOT ANTISTATIQUE
EN ISO 20347:2012 OB A E SRC ESD

Produced in Italy
Upper: in natural thermoplastic polymer rubber, latex free. Upper with closed top for prevent infiltration of organic and harmful substances and potentiate them harmful.
Sterilizable: in autoclave (up to 134 ° C for 70 minutes)
Toe: no
Anti-perforation foil: no
Sole: polymer rubber (SRC anti-slip)
Plus: side windows for foot ventilation and washing. Energy absorption in the heel area, anatomic footbed, safety flip-up strap with patented attachment, ESD.
Sizes: from 35 to 47
Colours: 020 green, 050 white, 040 blue
On request: black, yellow, blue navy, red, fuxia, orange and purple.

Microchip installation on request.



COLOR AVAILABLE ON REQUEST





ISSALINE work boots are reliable and safe

guaranteed from EN ISO 20347 and EN ISO 20345 certification. Available with or without a steel toe cap or foil, to suit different needs of construction sites, food and leisure industries.

The tank sole of these boots ensures exceptional friction on the floor or ground, allowing stable walking even on slippery surfaces. In addition, their practicality also extends to easy donning and to quick removal.

ISSALINE uses **REACH COMPLIANCE*** certified materials to ensure compliance with European standards against the use of long-term harmful substances, sustainable products that protect both you and the surrounding ecosystem.





***REACH certification**

EACH (Registration, Evaluation, Authorization and Restriction of Chemicals) Compliance certification refers to compliance of a chemical substance or chemical product with European Union regulations relating to registration, evaluation and authorization of chemicals.

The REACH regulation was introduced to ensure the protection of human health and the environment through the safe management of chemicals. REACH Compliance certification certifies that the substance or product meets the requirements of the REACH regulation and has been properly registered with the European Chemicals Agency (ECHA).

**06315R ISSAGUM
NITRILE RUBBER WORK BOOT (NITRILE PVC)
EN ISO 20347:2012 SRA**

Toe: no
Anti-perforation foil: no
Sole: tank
Plus: MPX (malleolus protection), compound containing nitrile for a better flexibility and durability of the boot; ergonomic shape for better comfort and heel insert to facilitate undressing.
Sizes: from 36 to 48
Colour: 050 white/grey, 090 brown/black



**06425R ISSAFORT
NITRILE RUBBER SAFETY BOOT (NITRILE PVC)
EN ISO 20345:2011 S5 SRA**

Toe: yes
Anti-perforation foil: yes
Sole: tank
Plus: MPX (malleolus protection), compound containing nitrile for a better flexibility and durability of the boot; ergonomic shape for better comfort and heel insert to facilitate undressing.
Sizes: from 36 to 48
Colour: 010 yellow/black, 020 green/black, 040 blue/red.



**06426R ISSAFORT
NITRILE RUBBER SAFETY BOOT (NITRILE PVC)
EN ISO 20345:2011 S4 SRA**

Toe: yes
Anti-perforation foil: no
Sole: tank
Plus: MPX (malleolus protection), compound containing nitrile for a better flexibility and durability of the boot; ergonomic shape for better comfort and heel insert to facilitate undressing.
Sizes: from 36 to 48
Colour: 050 white/grey.



06351R FULL THING BOOT

PVC application on the boot 06425R certified EN ISO 20345: 2011 S5 SRA
Colour: 020 green/black.

06361R DIVING BOOT

On the boot 06425R certified EN ISO 20345: 2011 S5 SRA one was applied PVC diving suit.
Colour: 020 green/black.





ISSAPOL BOOTS



06430

PU ISSA POL S5 METAL FREE BOOT

EN ISO 20345:2011 S5 SRC CI

Toe: composite.

Anti-perforation foil: Kevlar.

Sole: reinforced, with good stability and grip on all surfaces. Includes a riser that makes it easier removing the boots. Abrasion resistant sole.

Plus:

- 100% metal-free, which reduces weight and improves thermal insulation.
- Made with the best BASF polyurethane.
- SRC sole with great grip even on wet surfaces to ensure greater safety and stability.
- They do not break or crack at low temperatures (certified for thermal insulation at -30° C), nor with extreme changes in temperature.
- Resistant to oils, greases and a variety of chemicals.
- Antibacterial internal lining.
- Antistatic.
- The insole is removable, washable, orthopedic and antibacterial.
- TPU inserts in the sole for better anti-slip and greater durability.
- The insertion of TPU improves the performance of the sole by 10%.
- Absorbs energy in the heel.
- Very light.

Sizes: da 36 a 48.

Colour: 027 green/black.

06435 **only on request**

STIVALE PU ISSAPOL S4 METAL FREE

EN ISO 20345:2011 S4 SRC CI

Toe: composite.

Anti-perforation foil: Kevlar.

Sole: reinforced, with good stability and grip on all surfaces. Includes a riser that makes it easier removing the boots. Abrasion resistant sole.

Plus:

- 100% metal-free, which reduces weight and improves thermal insulation.
- Made with the best BASF polyurethane.
- SRC sole with great grip even on wet surfaces to ensure greater safety and stability.
- They do not break or crack at low temperatures (certified for thermal insulation at -30° C), nor with extreme changes in temperature.
- Resistant to oils, greases and a variety of chemicals.
- Antibacterial internal lining.
- Antistatic.
- The insole is removable, washable, orthopedic and antibacterial.
- TPU inserts in the sole for better anti-slip and greater durability.
- The insertion of TPU improves the performance of the sole by 10%.
- Absorbs energy in the heel.
- Very light.

Sizes: da 36 a 48.

Colour: 050 white



ISSALINE
BY PIP

Waterproof PVC boots that are ideal for use at work in situations where specific PPE certification is not required, but also for leisure and sports. Characterized by lightness, softness and comfort they offer during use. The lug sole provides excellent grip on the ground, thus allowing for greater safety and stability. Due to their practicality, these boots can be easily put on and taken off without any problems. These boots meet the strictest standards in terms of environmental safety. They are made with REACH COMPLIANCE* certified materials, thus ensuring that no harmful substances are present in the materials used within the manufacturing process.



***REACH certification**

EACH (Registration, Evaluation, Authorization and Restriction of Chemicals) Compliance certification refers to compliance of a chemical substance or chemical product with European Union regulations relating to registration, evaluation and authorization of chemicals.

The REACH regulation was introduced to ensure the protection of human health and the environment through the safe management of chemicals. REACH Compliance certification certifies that the substance or product meets the requirements of the REACH regulation and has been properly registered with the European Chemicals Agency (ECHA).

**06310R
PVC KNEE BOOT**

Colour: 020 green, 027 green-black, 060 black



**06301R
PVC ANKLE BOOT**

Colour: 020 green, 027 green-black.



**06314R
PVC KNEE BOOT**

Colour: 050 white
Full box: 10 pairs



**06350R
PVC FULL THIGH BOOT**

Colour: 020 green



**06360R
PVC DIVING BOOT**

Colour: 020 green



**06305R
PVC GALOSHES**

Colour: 020 green
No size 39





In order to ensure continuity in the foot protection project, ISSALINE has partnered with SALUBER, an Italian company specializing in the production of technical insoles made of genuine leather. This partnership has led to the creation of a range specially designed for safety footwear. The choice of genuine leather as the main material is based on its exceptional ability to keep the foot cool during summer and warm during winter.

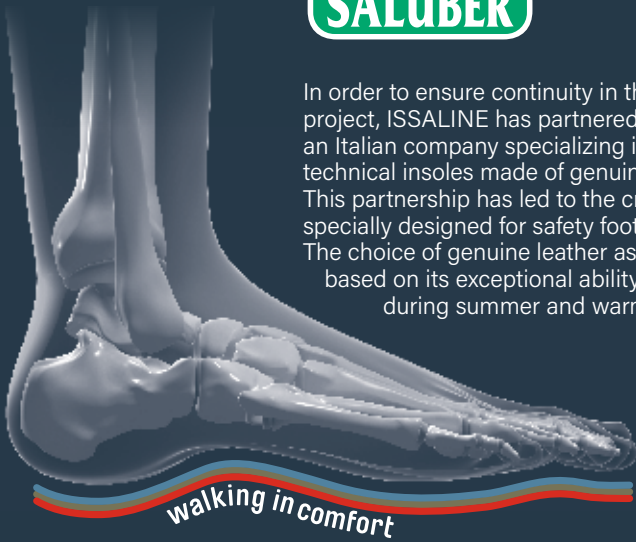

LEATHER

**LEATHER+
FOOTBED**

**WINTER+
FOOTBED**



438 DAILY

Insole in natural leather antistatic for safety footwear.

The leather promotes perspiration and prevents bad smells.

Sizes: 36-47

Full box: 5 pa.



401 COMFORT

Insole - anatomic antistatic footbed self-conforming in natural leather with active carbon membrane for safety footwear

Anatomic footbed in genuine leather, hygienic and insulating, with activated carbon membrane.

Highly self-conforming, integrated shock absorber on the heel.

Sizes: 36-47

Full box: 5 pa.



463 THERMO

Insole - anatomic antistatic footbed self-conforming in pure virgin wool for safety footwear

Anatomic footbed covered in pure virgin wool, hygienic and insulating. Made with membranana in felt that ensures excellent thermal insulation. The metatarsal area is designed to give flexibility with controlled torsion.

Integrated shock absorber on the heel.

Sizes: 36-47

Full box: 5 pa.



**Make unique
your point of
sale:**

- **ISSALINE WALL**
- **ISSALINE MODULAR SYSTEM** **NEW**
- **ISSALINE MODULAR WOOD** **NEW**



In the competitive world of retail, standing out is crucial to attracting and satisfying customers. With the "Modular ISSALINE" system, customizing your store becomes not only possible, but also a significant competitive advantage. Let me guide you through the endless customization possibilities offered by this innovative system, transforming your store into a unique customer experience.

The concept of Modular ISSALINE is based on the idea of making the most of the space available in your store, offering a modern, streamlined presentation of products, enhanced by explanatory graphics. Its flexibility allows it to adapt to the specific needs of your store, creating an attractive and functional environment that guides customers in choosing the Personal Protective Equipment (PPE) best suited to their needs.

One of the distinguishing features of the Modular ISSALINE system is its modularity. You can customize your store layout according to the size of the available space and your aesthetic preferences. Whether you need a wall display, islands of products in the center of the store, or a combination of both, Modular ISSALINE can be configured to meet your needs.

Imagine creating a display wall that captures customers' attention as soon as they enter your store. With Modular ISSALINE, you can organize your PPE into neatly arranged and orderly boxes, highlighting the features and benefits of each product through clear and informative educational elements. This not only makes it easier for customers to locate what they need, but also helps them make informed decisions about their purchasing choices.

Modular ISSALINE enhances your customers' experience, optimizes your store's operational efficiency. Its intuitive design and easy assembly saves time and resources during installation and maintenance. Furthermore, its durability and the possibility of modular upgrades ensure that your investment continues to provide value over time.

In store merchandising

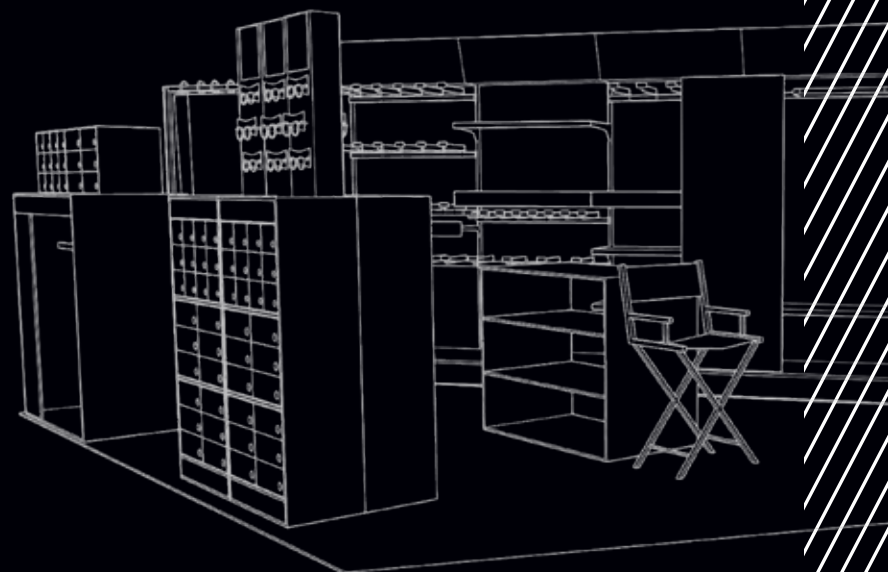

ISSALINE WALL

Make better use of your shop space



The new ISSALINE WALL concept is designed by combining a modern linear presentation with our box display system, enriching it with explanatory didactics. The result is a comprehensive proposal full of alternatives capable of attracting the end customer and guiding him in the choice of the best PPE.

Choose your module

The modules shown are made by composing the "BACK module" with the addition of some of the accessories shown here.



Art.	Description
00740401	SHELF HOLDER 400 mm
00740501	SHELF HOLDER 500 mm



Art.	Description
65022421	HANGING BAR 350x1000 mm



Art.	Description
62311221	UNIVERSAL BAR 1000 mm



Art.	Description
62600201	SHELF 300x1000 mm
62601201	SHELF 400x1000 mm
62602201	SHELF 500x1000 mm
62603201	SHELF 600x1000 mm



Art.	Description
22101401	PVC PRICE HOLDER 40x1000 mm



Art.	Description
03102821	BROCHE HOOK 350 mm
2218109898	BROCHE HOOK PRICE HOLDER POCKET



Art.	Description
900624	HANGER Full box: 80 pcs.



Art.	Description
BUL02001	INFOGRAPHIC SUPPORT 100x1000 mm



Art.	Description
20702421	CLOTHES HOOK 350 mm



Art.	Description
IND00321	SHOES RACK 140x300x180 mm

Module DORSAL

Art.	Description	q.tà
00196610	Adjustable foot for base	2
00200401	Base side closure 600x140mm	2
00300201	Base front closure 100x1000mm	1
00301201	Back head 200x1000mm	1
00312201	Back bottom unit 400x1000 mm	5
0110701401	Supporting perforated bracket 80x2360 mm	2
22101401	PVC price holder 40x1000 mm	1
62603201	Shelf 600x1000 mm	1
FT00101	Banner holder 1000x300 mm	1



Module APPAREL 1

Module BACK (see Module BACK)
+ following items

Art.	Description	q.tà
0980313	ISSALINE banner 980x310 mm	1
20702421	Clothes hook	2
62311221	Universal bar 1000 mm	1
65022421	Hanging bar 350x1000 mm	1



Excluded items.

Module APPAREL 2

Module BACK (see Module BACK)
+ following items

Art.	Description	q.tà
0980313	ISSALINE banner 980x310 mm	1
65022421	Hanging bar 350x1000 mm	2



Excluded items.

Module APPAREL 3

Module BACK (see Module BACK)
+ following items

Art.	Description	q.tà
0980313	ISSALINE banner 980x310 mm	1
65022421	Hanging bar 350x1000 mm	1
00740501	Shelf holder 500 mm	4
62602201	Shelf 500x1000 mm	2
22101401	PVC price holder 40x1000 mm	2



Excluded items.

Module GLOVES

Module BACK (see Module BACK)
+ following items

Art.	Description	q.tà
00740501	Shelf holder 500 mm	2
03102821	Broche hook 350 mm	24
0980103	Gloves' use infographic 980x100 mm	1
0980104	Gloves' norms infographic 980x100 mm	1
0980313	ISSALINE banner 980x310 mm	1
2218109898	Broche hook price holder pocket	24
62311221	Universal bar 1000 mm	4
BUL02001	Infographic support 100x1000 mm	1



Excluded items.

Module VARIOUS

Module BACK (see Module BACK)
+ following items

Art.	Description	q.tà
03102821	Broche hook 350 mm	11
0980313	ISSALINE banner 980x310 mm	1
2218109898	Broche hook price holder pocket	11
62311221	Universal bar 1000 mm	2
65022421	Hanging bar 350x1000 mm	1



Module SHELF

Module BACK (see Module BACK)
+ following items

Art.	Description	q.tà
00740501	Shelf holder 500 mm	6
0980313	ISSALINE banner 980x310 mm	1
22101401	PVC price holder 40x1000 mm	3
62602201	Shelf 500x1000 mm	3
IND00321	Shoes rack 140x300x180 mm	Optional. Quantity based on the footwear ordered



Excluded items.

Module FALL PROTECTION

Module BACK (see Module BACK)
+ following items

Art.	Description	q.tà
00740501	Shelf holder 500 mm	4
0980105	Infographie fall protection 1 980x100mm	1
0980106	Infographie fall protection 2 980x100mm	1
0980312	Akrobat banner 980x310 mm	1
62601201	Shelf 400x1000 mm	2
65022421	Hanging bar 350x1000mm	1
BULO2001	Infographic support 100x1000mm	2



Excluded items.

Module CORNER KIT

Art.	Description	q.tà
00740401	Shelf holder 400 mm	8
3040019	Banner 300x810x920 mm	1
00601501	Shelf 400 mm	4
00603501	Base shelf width 600 mm	1
0110701401	Supporting perforated bracket 80x2360 mm	2
00196610	Adjustable foot for base	2
00200401	Base side closure 600x140mm	2
00502401	Base front closure	1
00312501	Back bottom unit h 400 mm	5
00301501	Back bottom unit h 200 mm	1
FT00501	Banner holder h 300 mm	1
22114412	PVC price holder h 40x400 mm	4
22114612	PVC price holder ssh 40x600 mm	1



Excluded items.

CHANGING ROOM WITH CURTAIN

Art.	Description	q.tà
900600N	Changing room with curtain 950x900xh2000 mm	1



ISSALINE MODULAR SYSTEM **NEW**

With its versatility, the **ISSALINE MODULAR SYSTEM** adapts to a variety of spaces, offering a solution that is easily adaptable to all kinds of environments. A minimal design meets your store's needs while helping to define neat and well-organized environments.

To perform assembly, follow the instructions and technical diagrams included in the hardware packages. Use the included hardware scrupulously.

Notes: Digital User's Manual. By scanning the QR code in the packaging, you will be guided through the assembly process in a clear and detailed manner.



Art.	Description
900200	UPRIGHT aluminum cm 5 X 2.5 h 253 epoxy powder coating, adjustable bottom foot with non-slip + wall mount.



Art.	Description
900201	SHELF cm 92 X 47 OSB panel 25 mm thick



Art.	Description
900203	HANGING BAR 92 cm Aluminum epoxy powder coating.



Art.	Description
900204	BROCHES 19,5 cm. 6 pcs. package. To mount the broche you need the hanging bar.



Art.	Description
900205	GRAPHICS MOD. WALL cm 92 X 28



Art.	Description
900624	HANGER Full box: 80 pcs.

MODULAR MENSOLES

Art.	Description	q.tà
900200	UPRIGHT	2
900201	SHELF	4
900205	GRAPHIC PANEL	1



Excluded items.

MODULAR APPAREL 1

Art.	Description	q.tà
900200	UPRIGHT	2
900203	HANGING BAR	1
900201	SHELF	3
900205	GRAPHIC PANEL	1

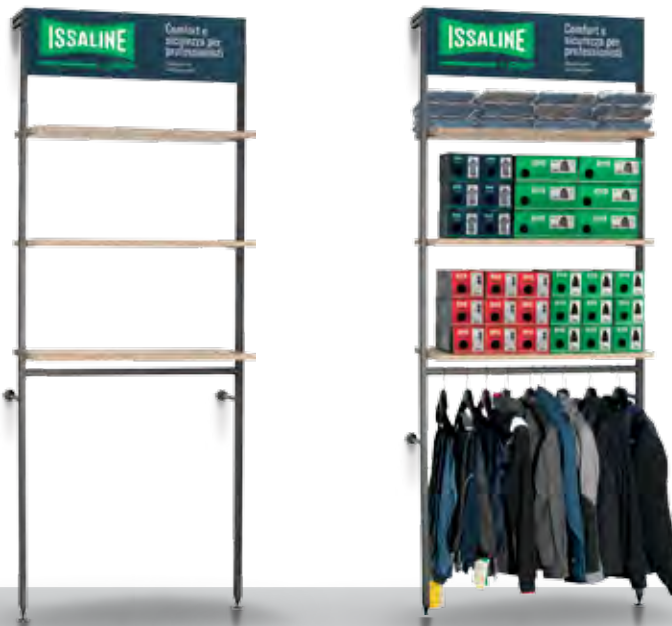

Excluded items.

MODULAR APPAREL 2

Art.	Description	q.tà
900200	UPRIGHT	2
900203	HANGING BAR	2
900205	GRAPHIC PANEL	1



Excluded items.

MODULAR APPAREL 3

Art.	Description	q.tà
900200	UPRIGHT	2
900203	HANGING BAR	1
900201	SHELF	2
900205	GRAPHIC PANEL	1

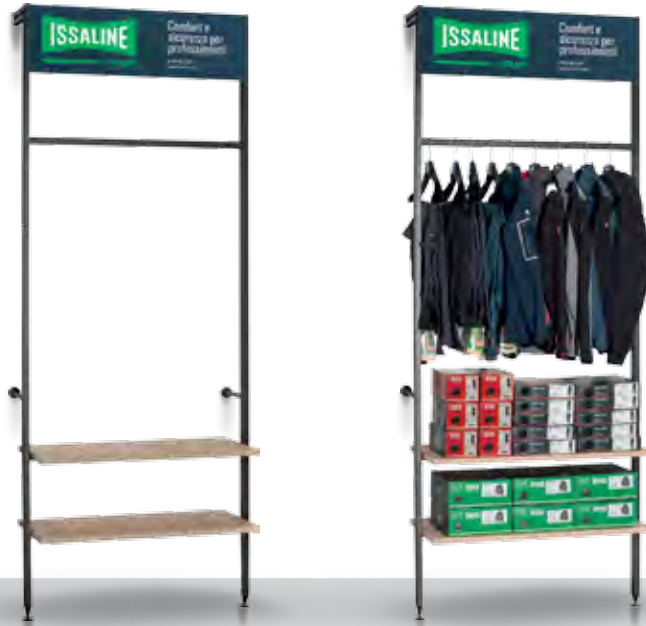

Excluded items.

MODULAR GLOVES

Art.	Description	q.tà
900200	UPRIGHT	2
900203	HANGING BAR	5
900204	BROCHES	5
900205	GRAPHIC PANEL	1



Excluded items.

MODULAR MISCELLANEOUS

Art.	Description	q.tà
900200	UPRIGHT	2
900203	HANGING BAR	3
900204	BROCHES	2
900205	GRAPHIC PANEL	1

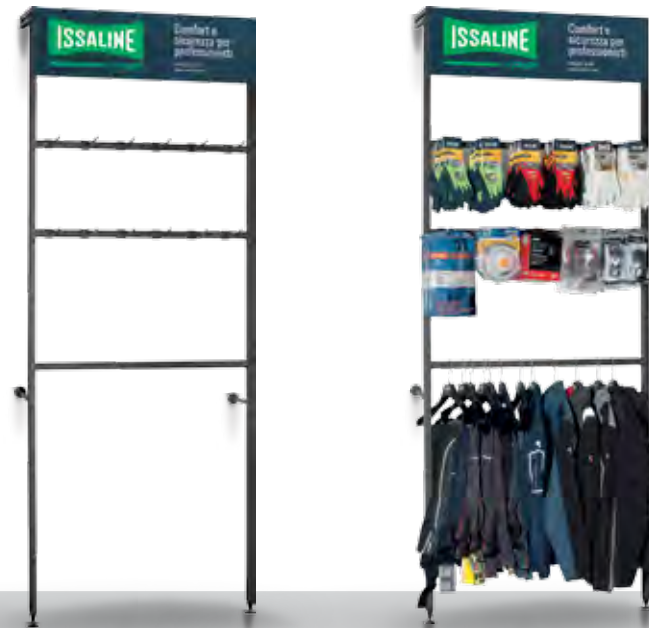

Excluded items.

ISSALINE MODULAR WOOD **NEW**

The Issaline Modular Wood system is made using OSB panels, which offer multiple possibilities for customizing display spaces. The Modular Wood concept consists of simple but sturdy elements that can be adapted to different display needs.

This project focuses on the optimisation and reorganisation of space within the shop, allowing the best possible display of products when a display island is required and wall shelving is not possible.

Modular Wood, with an industrial style, is designed to display workwear and PPE.

Follow the instructions and technical diagrams included in the hardware packages to perform assembly. Use the included hardware scrupulously.

900100 MODULAR APPAREL A

Made of OSB wood dim. 110 x h 130 x d 60 cm supplied with hanging bar.

900100SX

MODULAR A
graphics on Forex
panel dim. 60x130 cm.



900100DX

MODULAR A
graphics on Forex
panel dim. 60x130 cm.

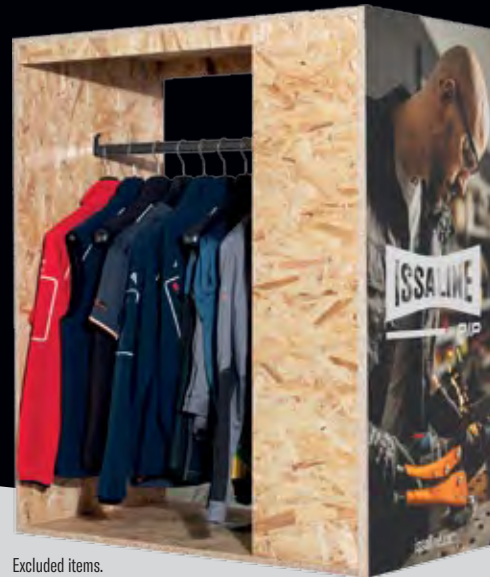

Excluded items.

900101 MODULAR APPAREL B

Made of OSB wood same structure as Modular A but with long hanging bar.
Dim. cm 110 x h 130 x d 60 supplied with hanging bar.

900101SX

MODULAR B
graphics on Forex
panel dim. 32x130 cm.



900101DX

MODULAR B
graphics on Forex
panel dim. 32x130 cm.



Excluded items.

900105 MODULAR F

Made of OSB wood dim. 110 x h 90 x d 60 cm
The two interior shelves are removable.

900105SX

MODULAR F
Graphics on Forex
panel dim. 60x90 cm.



900105DX

MODULAR F
Graphics on Forex
panel dim. 60x90 cm.



Excluded items.

900104
MODULAR E

Made of OSB dim. cm 57,5 x h 200 x p 34
The four interior shelves are removable.

900104SX

MODULAR E
Graphics on Forex
panel dim. 34x200 cm.



900104DX

MODULAR E
Graphics on Forex
panel dim. 34x200 cm.



Excluded items.



62713 Only on request

Director chair,
aluminum frame, folding.

900103
MODULAR
APPAREL D

Made of OSB wood dim. 57,5 cm x h 130 x d 34
The two interior shelves are removable.

900103SX

MODULAR D
graphics on Forex
panel size 34x130 cm.



900103DX

MODULAR D
graphics on Forex
panel size 34x130 cm.



Excluded items.

900603
SHOES DISPLAY ISSALINE
Excluded items.



900618
ESPOCUB
Excluded items.



900615
GLOVES DISPLAY ISSALINE
Convenient 12-position floor display, the display can also be used for face masks, headphones and glasses.
Excluded items.



GRIPPAZ FSDU
GLOVES DISPLAY GRIPPAZ
Practical cardboard floor display stand.
Excluded items.



indicative
image

251-DS-0009
DISPLAY 9 BOUTON
GLASSES
Excluded items.



900800
DISPLAY 5 BOUTON
GLASSES
Excluded items.



900616
GLOVE HOLDER "TIE"
Convenient 10-position wall display.
Used also with gloves in polybag.
Excluded items.





FLAG ISSALINE
900614
Base + flag.

900628
ROLL UP
EXTREME SHOES



900601
ESPOCKETS
Excluded items.



900619
COUNTER DISPLAY STAND
ISSALINE GLOVES
Excluded items.



900629
COUNTER DISPLAY STAND
G-TEK GLOVES
Excluded items.

900626
SHOE COUNTER DISPLAY STAND
Excluded items.



900606
Mannequin



900605
SAGOMA
Akrobat



900627
SAMPLEBAG
Excluded items.



900613
PVC banner with
eyelets. Size 150x80 cm



PIP

GLOBAL SAFETY



BRINGING THE BEST OF THE WORLD TO YOU®

AMERICAS

USA Corporate Headquarters & Sales Center

Latham, NY
Phone: 518-861-0133 · Toll Free: 800-262-5755
sales@pipusa.com · www.pipusa.com

USA New York Distribution Center

Guilderland Center, NY

USA California Sales & Distribution Center

Rancho Cucamonga, CA
Phone: 909-987-2350 · Toll Free: 800-225-9225

USA Tennessee Sales & Distribution Center

Memphis, TN
Phone: 901-370-5828 · Toll Free: 888-456-8378

USA Manufacturing Facility

Guilderland Center, NY

USA Manufacturing Facility

Bluffton, IN
Phone: 260-824-8146

USA Manufacturing Facility

Chaska, MN
Phone: 952-448-7430

Canada Distribution Center, Shipments & Returns

Bolton (Toronto), Ontario
Phone: 800-262-5755 x7258
www.pipcandada.ca

Mexico Sales & Distribution

Monterrey, N.L., Mexico
Phone: +52 (81) 8372-1825
www.pipmex.com

Mexico Regional Sales Office

San Pedro Garza García, N.L., Mexico
Phone: +52 (81) 8335-4744 · +52 (81) 1365-9569

ASIA PACIFIC - AUSTRALIA

Asia Pacific Administrative Headquarters

Hong Kong, China
Phone: 852-2475-9228
www.pipasiapacific.com

China Administrative & Sales Center

Shanghai, China
Phone: 86-021-63170303

China Regional Sales Office

Yantai City, Shandong Province, China
Phone: 86-0535-6602843

Singapore Sales Office

Singapore
Phone: +65-91557756

Malaysia Sales Office

Penang, Malaysia
Phone: 6-04-399-3328

PIP Australia

Eagle Farm, Queensland, Australia
Phone: 1300 656 010
www.pipaus.com

EUROPE

France Administrative & Sales Offices

L'hermenault, France
Phone: +33 (0) 2 51 50 19 80
www.pipeurope.com - info@pipeurope.com

INDUSTRIAL STARTER S.p.A.

Altavilla Vicentina, Italy
Phone: +39 0444 573 422
www.industrialstarter.com - info@ind-starter.com

INDUSTRIAL STARTER CZECH s.r.o.

Ostrava Radvanice, Česká Republika
Phone: +420 552 312 619
www.industrialstarter.com - infocz@ind-starter.com

KIT Safety

Dublin, Ireland
Phone: +1 353 1 642 3010
www.pipeurope.com

INDUSTRIAL STARTER ESPAÑA S.L.U.

Puzol (Valencia), España
Phone: +34 96 141 40 41
www.industrialstarter.com - comercial@starter.es

INDUSTRIAL STARTER POLSKA SP.Z O.O

Sosnowiec, Polska
Phone: +48 32 260 0026
www.industrialstarter.com - bok@industrialstarter.pl

ISM HEINRICH KRÄMER GMBH & CO. KG

Lippstadt, Alemania
Phone: +49 (0) 29 41 / 76 06 - 0
vertrieb@ism-europa.de

ULTIMATE INDUSTRIAL

Wolverhampton, United Kingdom
Phone: +44 (0)1902 451 451
www.ultimateindustrial.co.uk - sales@ultimateindustrial.co.uk



Altavilla Vicentina (Vicenza)



Valencia



EUROPE

PIP FRANCE ADMINISTRATIVE & SALES OFFICES

L'hermenault, France
Tel: + 33 (0) 2 51 50 19 80
www.pipeurope.com - info@pipeurope.com

ISM Heinrich Krämer GmbH & Co. KG

Lippstadt, Germany
Tel: +49 2941 76060
www.ism-europ.de - info@ism-europa.de

ULTIMATE INDUSTRIAL

Wolverhampton, United Kingdom
Tel: +44 1902 451451
www.ultimateindustrial.co.uk - info@ultimateindustrial.co.uk

INDUSTRIAL STARTER S.P.A.

Altavilla Vicentina (Vicenza), Italy
Tel: +39 0444 573422
www.industrialstarter.com - info@ind-starter.com

INDUSTRIAL STARTER CZECH S.R.O.

Ostrava Radvanice, Česká Republika
Tel: +420 552 312 619
www.industrialstarter.com - infocz@ind-starter.com

KIT SAFETY

Dublin, Ireland
Tel: +353 1642 3010
www.pipeurope.com - sales@kit.ie

INDUSTRIAL STARTER ESPAÑA S.L.U

Puzol (Valencia), España
Tel: +34 96 141 40 41
www.industrialstarter.com - comercial@starter.es

INDUSTRIAL STARTER POLSKA S.P.Z.O.O

Sosnowiec, Polska
Tel: +48 32260 0026
www.industrialstarter.com - bok@industrialstarter.pl

PIP
GLOBAL SAFETY